

# CITY OF NEW ORLEANS STORMWATER DRAINAGE SYSTEM ROOT CAUSE ANALYSIS FINAL REPORT

Solicitation Number: 2215-02270

PS-82R-17

Contract: K18-111

---

## Submitted by:

**ABS Group**  
16855 Northchase Drive  
Houston, TX 77060  
Office: (703) 351-3700  
Fax: (703) 682-7374



CITY OF NEW ORLEANS STORMWATER DRAINAGE SYSTEM

ROOT CAUSE ANALYSIS

FINAL REPORT

**NOTICE**

This work was supported by ABSG Consulting Inc. for the City of New Orleans under proposal number 4059986; contract K18-111.

This report was prepared by ABSG Consulting Inc. solely for the benefit of the City of New Orleans. Neither ABSG Consulting Inc., nor any person acting on their behalf, makes any warranty (express or implied) or assumes any liability to any third party with respect to the use of any information or methods disclosed in this report. Any third-party recipient of this report, by acceptance or use of this report, releases ABSG Consulting Inc. from liability for any direct, indirect, consequential, special loss or damage, whether arising in contract, tort (including negligence), or otherwise.

ABSG Consulting Inc. and its employees, subcontractors, consultants and other assigns cannot, individually or collectively, predict what will happen in the future. The investigation team made a reasonable effort, based on the information and scope of work provided by personnel, to help identify mechanical and operational deficiencies within the City of New Orleans drainage system.

The City of New Orleans should recognize that there may be other risks not addressed in this report. Regardless of what actions are taken in response to the information contained in this report, the potential exists for accidents and other abnormal events to occur. ABSG Consulting Inc. accepts no liability for any incident or regulatory action (international, federal, state, or local) that occurs with the City of New Orleans's drainage system, even if all the recommendations resulting from this incident investigation are thoroughly addressed.

## **EXECUTIVE SUMMARY**

The City of New Orleans sustained significant flooding due to several severe weather events that occurred on July 22, August 5 and August 8, 2017. These incidents resulted in standing water that measured over five feet for several hours in many neighborhoods resulting in substantial inconvenience and property losses among residents and businesses. The depth and duration of surface water from these events prompted growing concern among local officials and the general public as to whether deficiencies within the city's storm water management system might have exacerbated flooding. More specifically, three of the four turbines that are used to power the pumping of rainwater through the drainage system were not available during these rain events resulting in the drainage system having less than 10% of its designed self-produced power capacity. This diminished power availability, paired with pump outages at two drainage pump stations in the most impacted city drainage basins, relegated pumping capacity to 45-70% of design capabilities during these rain events. Additionally, at the time of the rain events, numerous catch basins and drain lines within impacted drainage basins were clogged, undersized, or otherwise compromised. Subsequently, on August 9, 2017 an electrical fault occurred disabling the remaining operational 25 Hz turbine generator; resulting in no capacity, to self-generate electricity for the city's drainage system for a short period of time.

In January 2018, ABS Group (ABSG) was contracted by the City of New Orleans to conduct a root cause analysis ("RCA") of the flooding which occurred on July 22, August 5 and August 8, 2017 and the turbine generator electrical fault on August 9, 2017 (collectively referred to as "the Loss Events"), inclusive of natural, mechanical and institutional factors. The scope also included development of recommendations for corrective actions.

## **METHODOLOGY**

The RCA investigated and analyzed the proximate causes (i.e., equipment and front-line personnel performance gaps) of the Loss Events, which are referred to as Causal Factors; including their origin, relationship to other Causal Factors and how they collectively caused the Loss Events. This investigation also included identifying the Intermediate and Root Causes of each Causal Factor based on personnel, leadership and other stakeholder interviews, as well as analyzing relevant data, budgeting and operational information, governance and decision-making structures, meeting transcripts and other information sources. Intermediate and Root Causes typically included performance gaps in budgeting, communications, decision-making processes, documentation, external factors, hazard/defect identification, human factors, leadership oversight, maintenance, materials/parts, operations and system designs, operational procedures, personnel performance and training, policy decision-making, and supervision. Recommended corrective actions are offered to address identified Causal Factors and their Root Causes.

In conducting the root-cause analysis of the flood-related Loss Events, this report uses the August 5th event as the focal point for the RCA given that all the flood events involved comparable Causal Factors and Intermediate and Root Causes. This event was also the most damaging because it involved the highest level of rainfall combined with pumping system performance issues. The August 9th turbine generator electrical fault is treated as a separate RCA investigation within this report.

## **CAUSE AND EFFECT TREE**

The August 5th Loss Event RCA is mapped for evaluation using a Cause and Effect Tree (CAET), which is a logic-based flow chart that outlines how the Causal Factors of the event and their Intermediate and Root Causes combined to cause the Loss Events. In general, a CAET illustrates Causal Factors which are front line personnel performance gaps or equipment performance gaps that are the direct cause of Loss Events and how multiple Intermediate and Root Causes can combine to give rise to the Causal Factors.

CAETs were developed for each of the New Orleans drainage basins that were impacted by the August 5th flood event. Within this framework, Causal Factors were organized into two categories: (1) Excessive Rainfall, inclusive of causal factors related to how much rain fell, the time period over which it fell and where the rainfall predominantly fell and migrated based on topography; 2) Inadequate Drainage System Performance, inclusive of system design, asset functionality, governance and operations within the entire physical drainage system, including those assets controlled by the Sewerage and Water Board of New Orleans (S&WB) as well as those drainage assets that are controlled and maintained by the City of New Orleans (“City”).

These separate categories reflect the difference in analyzing performance expectations and corrective measure options in addressing physical environmental (rainfall, topography, absorption, etc.) causal factors versus institutional causal factors stemming from system design, operational and governance root causes. For example, the volume of precipitation that fell into the city’s impacted drainage basins during the July and August Loss Events, will result in some degree of flooding given the current design capacity of the S&WB/City drainage system (the design-basis).

Regarding the physical environmental factors contributing to this flooding, the performance expectation is dependent on the level of flood risk tolerance. To the degree that flood risks are accepted, corrective actions would be centered on reducing damages and improving risk communications. To the degree that flood risks are not acceptable, altering the design of the S&WB/City drainage system to reduce flooding from such severe rainfall would be the course of action. Regarding institutional causal factors that contributed to the flooding, the CAET examination centered on the desired performance and corrective actions needed to reduce the degree of flooding experienced during severe rainfall such as the July and August Loss Events.

## **DEFINING THE LOSS EVENTS**

For purposes of the RCA, a Loss Event is defined as an event or incident with negative consequences that are a deviation from a normal or optimal performance or outcome that might otherwise be expected under the similar circumstances. The benchmark or “loss” encapsulating the August 9, 2017 event was the failure of Turbine Generator #1 at the S&WB Carrollton Water Plant due to an electrical fault, which was a clear deviation from what would be expected of that turbine when normally functioning. Establishing an expected performance benchmark by which to gauge the July 22, August 5 and August 8, 2017 flooding incidents as Loss Events is more difficult. This is because it is not apparent that New Orleans’ drainage system as a whole, from catch basins to canals, was intentionally designed to a uniform design standard whereby, if performing optimally, the system could knowingly minimize standing surface waters to an approximate depth and duration based on precipitation volume and duration intensity (“Level of Service”). In short, is there a basis by which the flooding experienced during

the July and August 2017 rain events can be held as in excess of what the drainage system was otherwise designed to accommodate under the same weather and physical circumstances?

S&WB and the City of New Orleans both indicated that new capital investments within their respective portions of the city's drainage system are being planned and scaled to prospectively assure that the system achieves a "10-year" storm event Level of Service; meaning that the collective system could drain rain impacted areas so that there would be on average no more than 6 inches of standing water for an hour or less in the event that approximately 8.5 inches of precipitation fell over 24 hours. Nonetheless, the RCA investigation found no clear historical evidence of any such Level of Service design, which could define the benchmark capacity of the collective system in the lead up to the July and August 2017 flood events.

Tellingly, absent a uniform and commonly understood Level of Service design, S&WB and the City of New Orleans have employed other types of separate and incompatible standards by which to gauge the performance and maintenance of their respective portions of the drainage system. For its part, S&WB employed a design and maintenance standard of performance for its portion of the drainage system (pipes and culverts 36-inches and larger in diameter; pump stations; turbines; and outfall canals), which defined success based on whether pumps could move 1-inch of storm water that had entered into drainage pipes during the first hour of a rain event and 0.5-inches for every hour thereafter. Conversely, notwithstanding the "10-year" Level of Service standard for new assets, it was not apparent that the City of New Orleans has historically invested in, repaired, inspected, or maintained its portion of the system (catch basins, earthen ditches and pipes under 36-inches in diameter) based on maintaining an understood designed Level of Service. Indeed, the most consistently employed performance gauge used by the City to define success in maintaining its portion of the drainage system is whether it reached an annual target of complaint-based catch basin and drain line cleanings and repairs. Problematically, none of the above standards provide a clear basis by which to gauge the severity of the July 22, August 5 and August 8, 2017 rain events relative to what can be expected of the drainage system as it exists.

In response to this lack of a defining Level of Service design for the then existing collective drainage system, the aspirational "10-year" storm event Level of Service was used as the performance gauge for the RCA. While not yet codified by ordinance, Mayoral executive order, or S&WB Board resolutions, the "10-year" storm event Level of Service is nonetheless the stated goal within the 2011 *City of New Orleans Stormwater Management Capital Improvements Plan* and, subsequently, now guides both S&WB and City of New Orleans investments and design changes with the overall physical system. As such, while the July and August 2017 rain events exceeded this rate in portions of the City, the 10-year storm Level of Service nonetheless provides a benchmark for a desired level of service against which drainage system performance during the flood-related Loss Events can be assessed and recommendations offered for improving system design and performance in line with that shared drainage service goal.

## **DATA COLLECTION**

Root cause investigation of the Loss Events entailed a wide-ranging data collection effort that included operational performance, maintenance, capital improvement and staffing data for both S&WB and City controlled drainage system assets. Specific sources of information included:

- Departmental management system structures and maintenance policies
- Meeting minutes, notes, transcripts, reports and other information from S&WB and City staff and executive meetings; S&WB Board of Directors meetings; and City Council proceedings
- Inspections at S&WB Central Control, selected pumping discharge stations, frequency changer stations and the East Bank power plant
- City Department of Public Works (DPW) modeling, maintenance logs, budget requests and allocations and inspection data related to catch basins and drain lines
- Information prepared by the New Orleans Department of Homeland Security and Emergency Preparedness, including damage assessments, flood claim data and communication actions during the Loss Events
- Interviews with key personnel to understand equipment and personnel performance gaps and contributing factors and root causes such as management systems and resources

## **LOSS EVENTS CAUSATION SUMMARIES**

### ***CITY OF NEW ORLEANS SEVERE RAIN EVENT FLOODING; JULY 22, AUGUST 5 and AUGUST 8, 2017:***

In the years, months and days leading to the July and August 2017 flood-related Loss Events, New Orleans City Leadership, inclusive of S&WB, City departments responsible for drainage related improvements, maintenance and emergency communications, and New Orleans City Council lacked adequate situational awareness of a growing risk of worsening flooding from severe rain events due to the collective threat of S&WB power generation turbines being increasingly offline for repairs, pump system assets being inadequately maintained and catch basins and subsurface drain lines deteriorating and being chronically clogged. The root causes of these causal factors and local government's insufficient awareness of the risk they posed, stem from a myriad of budgeting prioritization shortfalls, bureaucratic and leadership silos, communication disconnects, insufficient data gathering and analysis, operational inefficiencies and oversight gaps among relevant governmental entities. As a result, these causal factors and their root causes led to significant failures in the performance of drainage assets and related operations across the city's drainage system, which contributed to the depth and duration of flooding during the July and August 2017 Loss Events.

As presently designed, the combined S&WB/City drainage system is not capable of preventing flooding (more than 6 inches of standing water) during a 10-year storm frequency event. As such, even if S&WB and City drainage assets found to be problematic during the Loss Events had been fully functional during the Loss Events, flooding could be expected to occur. Nonetheless, the RCA and condition assessments performed after the flooding reveal multiple drainage system related causal factors that contributed to

flooding and which were created or exacerbated by deficiencies in the management, operations and governance of both portions of the city's drainage system.

Within the S&WB controlled portion of the system, the lack of available 25 Hz power was a key causal factor contributing to the Loss Events. Multiple requests from drainage pump stations to power operational pumps within the basins most impacted by the Loss Events had to be denied by S&WB Central Control because sufficient power was not available via either Entergy sourced electricity or self-generated electricity using S&WB's Turbines 1, 3, 4 and 5<sup>1</sup>. This was not a new issue as lack of sufficient, reliable power had been an increasing problem for drainage pumping operations. For over five years prior to the Loss Events, S&WB could self-generate up to only 65% of its full capacity because Turbine 4, one of the system's largest turbines at 20 MW, had been offline for restoration since 2012<sup>2</sup>.

This growing problem of unavailable S&WB turbines worsened significantly in early March, when, as relayed by S&WB staff leadership to the S&WB Board and two senior Mayoral representatives at meetings on March 13 and 15th, "for a time, S&WB lost all ability to self-generate power." Specifically, in March, Turbines 1, 3 and 5 had failed. While power generation from these assets was restored, Turbine 3 failed again in May followed by Turbine 5 in late July. As such, just prior to the August 5, 2017 Loss Event, S&WB could self-generate less than 10% of its designed 25 Hz power making capacity. Compounding this, unreliable electrical feeders, which relay S&WB generated power to pumping stations, further reduced available power to activate and run pumps during the July and August severe rain events. Finally, at many pumping stations, power was lost multiple times, causing pumps to trip offline, which further reduced pumping capacity in stations where pumps or related systems were out of service for repairs or maintenance. In all, at stations where major flooding occurred, peak available pumping capacity ranged from 45-70% of the installed pumping capacity during the August 5 flood event.

Within the City of New Orleans controlled portion of the drainage system, clogged or otherwise compromised catch basins and drainage lines also contributed to Loss Event flooding. While these are not uncommon problems in any municipal drainage system, the manner in which the City funds and manages the maintenance and improvement of these assets did not allow for problematic assets within Loss Event drainage basins to be more readily addressed. First, budgeted funds for drainage asset maintenance and capital improvements were consistently below what had been requested from the City's Department of Public Works (DPW), which is charged with managing the City's portion of the drainage system. This is partly because drainage maintenance ranked consistently lower in spending priority than funding for streetlight repairs and pothole filling in the City's "budgeting for outcomes" analysis.

Second, for at least the past seven years the City utilized a reactive drainage maintenance program that set an annual target of cleaning up to 7,000 catch-basins and adjacent drain lines based on citizen and City Council complaints. However, this complaint-based method did not include a consistent use of visual inspections or modeling to determine areas most in need of drainage asset maintenance or

---

<sup>1</sup> Turbine #2 does not exist. Turbine #6 is a back-up asset used to power the 60 Hz pumps at Drainage Pumping Station #1; Mississippi River water intake stations; and other 60 Hz equipment at the main water plant.

<sup>2</sup> See 2012 Report on Operations. Sewerage and Water Board of New Orleans (Black & Veatch).

repairs. This method could not assure that the City was operating at a sufficient systemwide performance baseline. Indeed, the City's commissioned 2011 Stormwater Management Capital Improvement Plan recommended a maintenance program that annually cleaned at least 8% of the underground drainage system, including 15% of known problem areas (200 miles of drain lines and 18,250 catch basins), along with a video-inspecting at least 8% of the underground drainage system (103 miles). Funding to achieve this end was requested by DPW but was ultimately rejected in its proposed 2017 operating budget.

Third, the bureaucratic process for identifying and addressing problematic catch basins and drain lines, paired with an overreliance on highly regulated federal grants, was found to cause additional delays in remediating known problems within the City's portion of the drainage system. These delays affected many catch basins and drain lines in drainage basins most impacted in the Loss Events. These catch basins and drain lines had also been previously compromised by Hurricane Isaac in 2012 but were not addressed prior to the 2017 Loss Events.

Finally, the failure to consolidate or better coordinate the long-standing bureaucratic division of the City's "catch basin to canals" drainage system between S&WB and the City gave rise to isolated, incompatible and inadequate performance standards, budgeting metrics and capital investment and operational planning. Over time, this has prevented S&WB, City and City Council leadership from more thoroughly and holistically assessing the collective impact that known offline or underperforming assets will have during severe weather events. By critical example, between March 2017, when the S&WB Board was alerted that all drainage-dependent turbine generators had failed and the July and August Loss Events, there was no evident follow-up or inquiries regarding what would happen during a severe rain event with so many turbines potentially being offline. During this time period there were at least four other monthly meetings of the full S&WB Board Meetings and its Governance, Strategy and Finance & Administration Committees, four monthly City Council meetings, one City Council Public Works Committee meeting and at least 17 weekly Mayoral cabinet meetings that included senior S&WB leadership representation.

In summary, New Orleans City Leadership lacks adequate controls for proactive oversight and support of the stormwater system. Years-long policy choices regarding increasing S&WB power generation, reactive funding of City catch basin and drain line maintenance and delays in instituting new long-term drainage funding sources have reinforced and worsened existing storm water system vulnerabilities.

### **SPECIFIC CAUSAL FACTORS, INTERMEDIATE/ROOT CAUSES & RECOMMENDATIONS FOR CORRECTIVE ACTION**

The Causal Factors of the Loss Events and their root causes as identified based on a CAET analysis of the events is provided below. Intermediate causes are discussed in the body of the report.

#### ***City of New Orleans Severe Rain Event Flooding; August 5, 2017: Causal Factors & Root Causes***

##### **Causal Factor 1:**

There was insufficient 25 Hz power to supply all required pumps due to turbine generators 3, 4 and 5 being out of service for maintenance



**Root Cause 1.1: Insufficient Planning & Risk Awareness of Power Generation Systems** – S&WB Board of Directors and management failed to develop a clear and actionable strategy and implementation plan for establishing a minimum threshold of self-generated 25 Hz power. This plan should have included the minimum electrical power to be generated at any time to meet the demands of severe weather events, including as needed the activation of temporary generation options to meet that threshold power need while offline turbines are repaired or restored.

**Root Cause 1.2: Inadequate Long-Term Funding Strategy to Address Known Problematic Turbines** – S&WB Board of Directors and management did not ensure adequate funding to repair Turbine 3 when it was identified as a capital improvement priority as early as 2011 and did not direct sufficient funding to meet growing maintenance and repairs needs among Turbines 1, 3 and 5. This funding shortfall was due, in part to concerns prior to the December 2016 expiration of one S&WB's three drainage millages that the tax millage would not be renewed by the electorate, leaving less funding to meet deferred and emerging costs.

**Root Cause 1.3: Increased Reliance & Demand on Aging Turbines for Daily Non-Drainage Related Systems** – City and S&WB leadership's strategic decision, at least as early as 2011, to increase the use of Turbines 1, 3 and 5 to meet non-drainage (e.g. potable water treatment and pumping) needs, in addition to servicing the drainage system, placed additional demands on the turbines. S&WB did not provide for monitoring to recognize that the periods that Turbines 1, 3 and 5 were offline due to problems and maintenance was increasing over this period, nor did leadership make provision for increased maintenance funding to minimize periods of power unreliability among these assets.

**Root Cause 1.4: Inconsistent Leadership Oversight of Turbine Related Problems and Repairs** - City leadership, inclusive of the Mayor, S&WB Board of Directors and Senior Management and the New Orleans City Council, did not consistently and thoroughly track, follow-up and assess the effectiveness of known repair and maintenance work being done on Turbines 1, 3, 4 and 5, particularly after S&WB ratified emergency spending to restore lost 25-Hz power generation capacity in March 2017.

The years-long delay in completing the restoration of Turbine 4 forestalled commencement of Turbine 3 refurbishment, which was identified as in need of major repairs as early as 2011. These repairs were to be completed as part of S&WB's Retrofit Power Plant Hazard Mitigation Grant Project but were continuously stated in annual plans as a project to be done upon completion of Turbine 4.

**Causal Factor 2:**

There was insufficient 25 Hz power to supply all required pumps due lack of available electrical feeders.

**Root Cause 2.1: Inadequate Budgeted Funding for Inspection and Repairs** – S&WB Board of Directors and management did not ensure adequate funding of capital improvements, inspections and repairs/ maintenance at an adequate level to maintain sufficient electrical feeders to meeting pumping requirements.

**Causal Factor 3:**

Continuous power from redundant and back-up sources was not reliably conveyed to otherwise operable drainage pumps causing them to trip offline and cease functioning.

**Root Cause 3.1: Inadequate Proactive Planning to Assure Inspections and Repairs of Feeders and Protocols for Alternative Power Sourcing and Conveyance** – S&WB Board of Directors and management failed to develop a clear and actionable strategy and implementation plan for inspecting and replacing electrical feeders to assure a threshold level of performance during severe rain events.

**Root Cause 3.2: Inadequate Long-Term Funding Strategy to Address Known Power Conveyance Limitations and Problems** – S&WB Board of Directors and management did not ensure adequate funding of capital improvements, inspections and repairs/maintenance at an adequate level to maintain sufficient electrical feeders to meet pumping requirements.

**Root Cause 3.3: Continuous Reliance on Outage Prone Distribution Lines** - S&WB and the relevant local privately-owned power utility, Entergy, did not utilize commercially rated external power feeds (transmission lines) for critical drainage system related assets, which resulted in unreliable power distribution from sources alternate to S&WB turbines.

#### **Causal Factor 4:**

There was an insufficient number of operable pumps at Drainage Pump Station (DPS) 6 and 7 due to maintenance issues, more specifically, about 45% of installed pumping capacity at DPS 6 and 37% of pumping capacity were out of service during the Loss Event.

**Root Cause 4.1: Inadequate Pump Asset Maintenance Planning** - S&WB management did not have an adequate inspection, preventative maintenance and project delivery protocols in place to ensure that problematic assets are more quickly identified and remedied. As a result, pump maintenance was reactive rather than preventative, resulting in sudden failure and lack of adequate time to plan and implement repairs.

**Root Cause 4.2: Inadequate Long-Term Funding Strategy to Address Deferred and Emerging Pump System Problems** – S&WB Board of Directors and management did not ensure adequate funding of capital improvements, inspections and repairs/maintenance to maintain sufficient levels of operable pump assets across the system.

**Root Cause 4.3: Inconsistent Leadership Oversight of Pump System Related Problems and Repairs** - City leadership, inclusive of the Mayor, S&WB Board of Directors and Senior Management and the New Orleans City Council, did not consistently and thoroughly track, follow-up and assess the effectiveness of known major repair work being done on pump assets across the system, nor did S&WB have adequate means for tracking, analyzing and communicating how overall pumping capacity at DPS stations is impacted based on multiple pump assets being offline for repairs or maintenance.

**Root Cause 4.4: Maintenance** – Pump maintenance was reactive rather than preventive. Incidental preventive maintenance was performed by station operators but there was not a written program for drainage assets and data collection necessary to identify and address maintenance issues before equipment failure occurred.

#### **Causal Factor 5:**

The drainage pumping system had inadequate design capacity to remove water from drainage basins.

**Root Cause 5.1: Performance Standards Were Not Established** - S&WB operations management did not establish and maintain minimum conditions of operations to include pumping capacity for each drainage pumping station.

**Root Cause 5.2: Ineffective Oversight Relative to Needed System Design Capacity** - S&WB did not provide sufficient oversight to ensure the drainage pumping system was available to operate at design capacity and to establish minimum conditions of operations for the drainage system.

**Root Cause 5.3: Inadequate Drainage Related Capital Improvement Assessment and Implementation Strategy Relative to Known Physical Environmental Factors within New Orleans Drainage Basins** – The City and S&WB did not jointly develop nor do they utilize a comprehensive (City/S&WB assets) drainage master plan by which policy, investment and operational procedures could be developed to assure that drainage pumping system capacity performs at the Level of Service needed to more effectively drain the City’s drainage basins based on known factors including topography, pervious surface area, water retention capacity and subsidence rates.

**Causal Factor 6:**

Pumps were not moving water efficiently due to mechanical integrity issues.

**Root Cause 6.1: Inadequate Pump Asset Maintenance Planning** - S&WB management did not have in place adequate inspection, preventative maintenance and project delivery protocols to ensure that problematic assets are more quickly identified and remedied. As a result, pump maintenance was reactive rather than preventative resulting in sudden failure and lack of adequate time to plan and implement repairs.

**Root Cause 6.2: Inadequate Long-Term Funding Strategy to Address Deferred and Emerging Pump System Problems** – S&WB Board of Directors and management did not ensure adequate funding of capital improvements, inspections and repairs/ maintenance to maintain sufficient levels of operable pump assets across the system.

**Root Cause 6.3: Inconsistent Leadership Oversight of Pump System Related Problems and Repairs** - City leadership, inclusive of the Mayor, S&WB Board of Directors and Senior Management and the New Orleans City Council, did not consistently and thoroughly track, follow-up and assess the effectiveness of known major repair work being done on pump assets across the system, nor did S&WB have adequate means for tracking, analyzing and communicating how overall pumping capacity at drainage pumping stations is impacted based on multiple pump assets being offline for repairs.

**Causal Factor 7:**

Pumps ran backwards for long durations reducing pumping capacity and recharging the suction basin

**Root Cause 7.1: Inadequate Pump Asset Maintenance Planning** - S&WB management did not have in place adequate inspection , preventative maintenance and project delivery protocols to ensure that problematic assets are more quickly identified and remedied. As a result, pump maintenance was reactive rather than preventative resulting in sudden failure and lack of adequate time to plan and implement repairs.

**Root Cause 7.2: Inadequate Long-Term Funding Strategy to Address Deferred and Emerging Pump System Problems** – S&WB Board of Directors and management did not ensure adequate funding of capital improvements, inspections and repairs/ maintenance to maintain sufficient levels of operable pump assets across the system.

**Root Cause 7.3: Inconsistent Leadership Oversight of Pump System Capacity Limitations and Problems** - City leadership, inclusive of the Mayor, S&WB Board of Directors and Senior Management and the New Orleans City Council, mindful of repairs and other factors rendering assets offline, did not consistently and thoroughly assess whether the pumping system was available to operate at design capacity during a declared “rain load” event such as the Loss Events.

**Causal Factor 8:**

Drainage pipes that the City controls and situated with drainage basins impacted by the Loss Events, were clogged or broken.

**Root Cause 8.1: Inadequate Long-Term Capital Improvement and Maintenance Planning Based on City Controlled Drainage System Importance and Vulnerabilities** – In lieu of the more proactive inspection and maintenance recommended by the City’s 2011 Stormwater System Improvement Plan, City leadership pursued a more reactive based approach based on responding to specific drainage asset complaints, which precluded the City from being able to establish a system-wide baseline of cleared assets that could then be maintained annually based on routine inspections.

**Root Cause 8.2: Inadequate Funding for Departmental Drainage Maintenance and Investment Requests** – City leadership funded drainage pipe related inspections and maintenance at lesser levels than requested by the Department of Public Works (DPW) based on prioritizing drainage related maintenance lower than other competing interests for limited DPW funding including streetlight repairs and pothole filling.

**Root Cause 8.3: Bureaucratic Inefficiencies and Limitations Hamstrung the Ability to More Proactively and Expeditiously Clean Clogged Drain Lines** – The ability to annually identify and clean more clogged drain lines, including many assets identified after Hurricane Isaac in the drainage basins which were later impacted by the Loss Events, was made more difficult by budgetary and training program challenges to provide a sufficient number of capable personnel. An overreliance on federal grant monies for DPW drainage asset needs, required more regulatory processes to use versus general budget funding and was not able to be used for maintenance pursuant to the City’s interpretation of applicable regulations.

**Causal Factor 9:**

Catch basins and inlets within the drainage basins impacted by the Loss Events were clogged and broken.

**Root Cause 9.1: Inadequate Long-Term Capital Improvement and Maintenance Planning Based on City Controlled Drainage System Importance and Vulnerabilities** – See, Root Cause 8.1 for similar details.

**Root Cause 9.2: Inadequate Funding for Departmental Drainage Maintenance and Investment Requests** – See, Root Cause 8.2 for similar details.

***Root Cause 9.3: Bureaucratic Inefficiencies and Limitations Hamstrung the Ability to More Proactively and Expeditiously Clean Clogged Drain Lines*** – See, Root Cause 8.3 for similar details.

**Causal Factor 10:**

The portion of the drainage system controlled by the City of New Orleans lacked sufficient design drainage capacity, including thousands of miles of drain lines, which the City has acknowledged needs to be widened and modernized.

***Root Cause 10.1: Inadequate Dedicated Long-term Funding & Policy Support*** – Unlike the S&WB controlled portion of the City’s drainage system, those assets controlled and maintained by City leadership lack a dedicated source of revenue from which capital improvements and maintenance can be accommodated without having to be prioritized among other competing important interests in the governance of New Orleans. Further, while subsurface potable water and sewer lines are being reconstructed as part of overall street reconstruction funded by over \$2 billion in post-Hurricane Katrina funding from the Federal Emergency Management Agency (FEMA), those monies cannot be used to similarly install new and wider drain lines under those streets. In part, this is because the City lacked pre- and post-storm inspection data by which to demonstrate the impact of Katrina related flooding on drainage assets. As such, FEMA would not allow this particular federal disaster recovery funding to be used towards the implementation of new drain lines.

**Causal Factor 11:**

Rainfall in three drainage basins during the Loss Events exceeded the “design storm” capacity of the City controlled portion of the overall drainage system.

***Root Cause 11.1*** - The amount of precipitation that fell during the Loss Event and then migrated to lower lying drainage basins was more volume of water than what the City’s total amount of catch basins and minor lines in those areas could store so as to prevent standing waters in excess of 6 inches.

**Causal Factor 12:**

Rainfall in four drainage basins during the Loss Event exceeded the “design storm” capacity of the S&WB controlled portion of the overall drainage system.

***Root Cause 12.1*** -: The amount of precipitation that fell during the Loss Event and then migrated to lower lying drainage basins was more volume of water than what S&WB’s portion of the drainage system, including fully functioning turbines and pumps, could convey through drain lines to outfall canals to prevent standing waters in excess of 6 inches.

***Item of Note***

The public was not warned in a timely manner about street flooding causing traffic to enter flooded streets.

A deficiency was noted in the communication of potential flooding by the City. While this did not create flooding, it failed to mitigate the consequences for some residents and is an opportunity for improvement.

The City's Office of Communications procedures prevented the New Orleans Office of Homeland Security from issuing flood advisories to the public without prior approval. Moreover, S&WB and the City do not utilize the existing S&WB "rain load" event designation for broader severe rainfall safeguarding, including coordination with City agencies or public communications in preparation or during the event. Instead, it is solely used by S&WB power related personnel to ready generators in anticipation of rain events.

### **CORRECTIVE ACTION MEASURES TO ADDRESS LOSS EVENT CAUSAL FACTORS & ROOT CAUSES**

The following are recommended governance, policy, procedural and operational reforms that the City of New Orleans and the Sewerage and Water Board of New Orleans should consider in correcting or mitigating identified root causes of August 5th flooding causal factors. Reflected below, several recommendations would apply to multiple causal factors and root causes. Further, recommendations are based on relevant industry best practices, prior recommendations made to the City and S&WB, feedback and observations made as part of this root cause analysis.

#### ***CITY OF NEW ORLEANS SEVERE RAIN EVENT FLOODING; AUGUST 5, 2017***

##### ***Recommendation #1:***

S&WB management team should develop a Power Resiliency Plan that establishes minimum performance requirements and operational plans to ensure backup power is provided for all drainage operations.

##### ***Causal Factors & Root Causes Addressed:***

Causal Factor 1: There was insufficient 25 Hz power to supply all required pumps due to Turbines 3, 4 and 5 being out of service for restoration or maintenance.

Root Cause 1.1: Insufficient Planning & Risk Awareness of Power Generation Systems

Root Cause 1.3: Increased Reliance & Demand on Aging Turbines for Daily Non-Drainage Related Systems

##### ***Recommendation #2:***

New Orleans City Leadership, inclusive of the Mayor's Office, S&WB Board of Directors and senior management and the City Council, should maintain more consistent and probing situational awareness of the readiness of the city's drainage-dependent turbines and pump system assets. At a minimum, this should include monthly or more frequent reports issued by the S&WB Executive Director and submitted to S&WB Board of Directors, the Mayor, City Council and available publicly that summarize the readiness of power and pumping operations, stated needs for repairing or restoring offline assets, the status of any such remedial actions and details on contingency plans. Further, it is recommended that if plans to repair or restore problematic turbines are not begun within three months of scheduled timelines for commencement or are not finished within a comparable timeframe, then protocols should exist to trigger an assessment and reporting of the risks of such delays and a determination of alternative pathway solutions.

***Causal Factors & Root Causes Addressed:***

Causal Factor 1: There was insufficient 25 Hz power to supply all required pumps due to Turbines 3, 4 and 5 being out of service for restoration or maintenance.

Root Cause 1.1: Insufficient Planning & Risk Awareness of Power Generation Systems

Causal Factor 6: Pumps were not moving water efficiently due to mechanical integrity issues.

Root Cause 6.3: Inconsistent Leadership Oversight of Pump System Related Problems and Repairs

Causal Factor 7: Pumps ran backwards for long durations reducing pumping capacity and recharging the suction basin.

Root Cause 7.3: Inconsistent Leadership Oversight of Pump System Capacity Limitations and Problems

***Recommendation #3:***

New Orleans City Leadership, inclusive of the Mayor's Office, S&WB Board of Directors and senior management and the City Council should prepare and implement strategies to ensure adequate, sustainable and coordinated funding for operations, maintenance and capital improvements within the entire city drainage system. For example, New Orleans City leadership should collaborate jointly to create a sustainable long-term source of funding for deferred and emerging expenses within the entire city drainage system. One thoroughly researched concept is a drainage service fee whereby parcel owners pay a monthly fee based on the size of their property, discounted by the volume of water detained or otherwise held back from entering the drainage system. This fee would be used to issue bonds for deferred and future capital improvements as well as annual maintenance and operations of the entire drainage system, inclusive of assets currently separate in administration between S&WB and the City. In 2016, S&WB commissioned the completion of a proposed fee structure, which is now complete but remains in final draft form and not yet formally presented to the public.

Incident to establishing a single funding source to service the city's drainage system, S&WB and the City should consider a single, or at least better coordinated, drainage system capital planning process to more regularly establish, refine and communicate progress and hurdles on project identification and prioritization, project design and alternative vetting, fund sourcing and monthly implementation progress updates. Further, both S&WB and the City should employ a service delivery focused on a "budgeting for outcomes" process used for establishing annual drainage system budgets. Such a budgeting process uses drainage flow mapping and asset inspection data to set yearly performance goals and an asset criticality hierarchy for determining annual maintenance and capital budgets, projects lists and metrics for project delivery accountability.

***Causal Factors & Root Causes Addressed:***

Causal Factor 1: There was insufficient 25 Hz power to supply all required pumps due to Turbines 3, 4 and 5 being out of service for restoration or maintenance.

Root Cause 1.2: Inadequate Long-Term Funding Strategy to Address Known Problematic Turbines

Causal Factor 2: There was insufficient 25 Hz power to supply all required pumps due to lack of available electrical feeders.

Root Cause 2.1: Inadequate Budgeted Funding for Inspection and Repairs

Causal Factor 3: Continuous power from redundant and back-up sources was not reliably conveyed to otherwise operable drainage pumps causing them to trip offline and cease functioning.

Root Cause: 3.2: Inadequate Long-Term Funding Strategy to Address Known Power Conveyance Limitations and Problems

Causal Factor 4: There were an insufficient number of operable pumps at Drainage Pump Station (DPS) 6 and 7 due to maintenance issues. Specifically, approximately 45% of constructed pumping capacity at DPS 6 and 37% of pumping capacity were out of service during the Loss Event.

Root Cause 4.2: Inadequate Long-Term Funding Strategy to Address Deferred and Emerging Pump System Problems

Causal Factor 6 (G10): Pumps were not moving water efficiently due to mechanical integrity issues.

Root Cause 6.2: Inadequate Long-Term Funding Strategy to Address Deferred and Emerging Pump System Problems

Causal Factor 7: Pumps ran backwards for long durations reducing pumping capacity and recharging the suction basin.

Root Cause 7.2: Inadequate Long-Term Funding Strategy to Address Deferred and Emerging Pump System Problems

Causal Factor 8: Drainage pipes that the City controls and situated with drainage basins impacted by the Loss Events, were clogged or broken.

Root Cause 8.1: Inadequate Long-Term Capital Improvement and Maintenance Planning Based on City Controlled Drainage System Importance and Vulnerabilities

Root Cause 8.2: Inadequate Funding for Departmental Drainage Maintenance and Investment Requests

Root Cause 8.3: Bureaucratic Inefficiencies and Limitations Hamstrung the Ability to More Proactively and Expeditiously Clean Clogged Drain Lines

Causal Factor 9: Catch basins and inlets within the drainage basins impacted by the Loss Events were clogged and broken.

Root Cause 9.1: Inadequate Long-Term Capital Improvement and Maintenance Planning Based on City Controlled Drainage System Importance and Vulnerabilities

Root Cause 9.2: Inadequate Funding for Departmental Drainage Maintenance and Investment Requests

Root Cause 9.3: Bureaucratic Inefficiencies and Limitations Hamstrung the Ability to More Proactively and Expeditiously Clean Clogged Drain Lines

Causal Factor 10: The portion of the drainage system controlled by the City of New Orleans lacked sufficient design drainage capacity, including thousands of miles of drain lines, which the City acknowledges needs to be widened and modernized.



Root Cause 10.1: Inadequate Dedicated Long-term Funding & Policy Support

**Recommendation #4:**

New Orleans City Leadership, inclusive of the Mayor's Office, S&WB Board of Directors and senior management and the City Council should maintain more effective situational awareness of the status of the city's drainage system turbines and more fully consider all ramifications in deciding the allocation of turbine use for water system needs. Foremost, S&WB management should constantly and transparently monitor and evaluate the impact of maintaining its increased reliance on internally generated power on the readiness and long-term functionality of its permanent power assets and revise the proposed Power Resiliency Plan as required. At a minimum, S&WB's monitoring and analysis of how power allocation decisions are impacting asset reliability and vulnerability should be a regularly reported and discussed assessment as part of a regular infrastructure briefing to the Mayor and his senior advisers along with being incorporated into more regularly scheduled public briefings to the City Council.

**Causal Factors & Root Causes Addressed:**

Causal Factor 1: There was insufficient 25 Hz power to supply all required pumps due to Turbines 3, 4 and 5 being out of service for restoration or maintenance.

Root Cause 1.3: Increased Reliance & Demand on Aging Turbines for Daily Non-Drainage Related Systems

**Recommendation #5:**

Situational awareness relative to the construction, repair and maintenance of the city's drainage-dependent turbines should be paramount among New Orleans City leadership, inclusive of the Mayor's Office, S&WB Board of Directors and senior management and the City Council. As such, the following policy and procedural changes are recommended: (1) S&WB Board of Directors should significantly improve the frequency and effectiveness of its oversight activity by requiring monthly or more frequent reports by the S&WB Executive Director on the operational status of critical drainage systems (e.g., turbines, pumps assets and frequency converters), how many and which assets are offline, the status of maintenance projects for critical systems and an assessment of readiness to meet a to-be-established city performance benchmark for the existing drainage system (modeled S&WB/City System design-basis rain storm scenarios); (2) Amend the state law authorizing the S&WB Executive Director and General Superintendent to pursue bid-less emergency repairs (La R.S. 33.4084) to require more stringent follow-up project status reporting requirements to the City Council and Board of Directors; (3) Amend S&WB Board of Director procedures to require a project status update for any work involving turbines at monthly general board meetings; (4) Include regular updates on the status of any repairs and maintenance involving turbines as part of any information requests made by City Council to S&WB, including during any testimony before the Council; and (5) Include a monthly status update on any emergency repairs projects involving S&WB power and pumps assets as part of schedule briefings of the Mayor by her/his cabinet and/or S&WB Board representative designee.

**Causal Factors & Root Causes Addressed:**

Causal Factor 1: There was insufficient 25 Hz power to supply all required pumps due to Turbines 3, 4 and 5 being out of service for restoration or maintenance.

Root Cause 1.4: Inconsistent Leadership Oversight of Turbine Related Problems and Repairs

Causal Factor 4: There were an insufficient number of operable pumps at Drainage Pump Station (DPS) 6 and 7 due to maintenance issues. Specifically, approximately 45% of constructed pumping capacity at DPS 6 and 37% of pumping capacity were out of service during the Loss Event.

Root Cause 4.3: Inconsistent Leadership Oversight of Pump System Related Problems and Repairs

Causal Factor 5: The drainage pumping system had inadequate design capacity to remove water from drainage basins.

Root Cause 5.2: Ineffective Oversight Relative to Needed System Design Capacity - S&WB did not provide sufficient oversight to ensure drainage pumping system was available to operate at design capacity and to establish minimum conditions of operations.

Causal Factor 7: Pumps ran backwards for long durations reducing pumping capacity and recharging the suction basin.

Root Cause 7.1: Inadequate Pump Asset Maintenance Planning

***Recommendation #6:***

S&WB and City leadership should consider immediately redirecting available capital and maintenance funds to resolve prioritized repair needs among the drainage system's electrical feeders. This funding should be implemented by instituting a proactive, long-term budgeting, inspection and maintenance program to assure feeders are optimally functioning and can deliver sufficient power to meet performance benchmarks for modeled S&WB/City System design-basis rain storm scenarios. At a minimum, this program should (1) Complete inspection of all system electrical feeders and prioritize replacements and repairs based on confirmed degrees of deterioration or malfunction, (2) Redirect available capital and maintenance funds to resolve prioritized repair needs and set forth a proactive timeline and budget strategy for assuring all system feeders are optimally functioning and (3) Institute a more proactive inspection and maintenance program that establishes clear benchmarks for gauging asset performance health (e.g., functional, problematic, eminent failure, failure) and utilizes regular inspections, repairs and related communications to leadership to assure maintenance and repairs occur expeditiously.

***Causal Factors & Root Causes Addressed:***

Causal Factor 2: There was insufficient 25 Hz power to supply all required pumps due to lack of available electrical feeders.

Root Cause 2.1: Inadequate Budgeted Funding for Inspection and Repairs

Causal Factor 3: Continuous power from redundant and back-up sources was not reliably conveyed to otherwise operable drainage pumps causing them to trip offline and cease functioning.

Root Cause 3.1: Inadequate Proactive Planning to Assure Inspections and Repairs of Feeders and Protocols for Alternative Power Sourcing and Conveyance

**Recommendation #7:**

New Orleans City Leadership, inclusive of the Mayor, S&WB Board of Directors and senior management and the City Council should advance S&WB's ongoing studies of alternative power sourcing options that would provide more reliable commercially rated electrical service for drainage operations. Specifically, City Leadership should collaborate jointly to negotiate a long-term power generation solution that involves both reliable onsite power sourcing (e.g., the long-proposed power utility substation based at the Carrollton Water Plant); as well as assuring that critical water systems, including the city's power-dependent drainage assets, are not reliant on power being transmitted via overhead distribution lines, which are highly prone to disruption.

**Causal Factors & Root Causes Addressed:**

Causal Factor 3: Continuous power from redundant and back-up sources was not reliably conveyed to otherwise operable drainage pumps causing them to trip offline and cease functioning.

Root Cause 3.3: Continuous Reliance on Outage Prone Distribution Lines

**Recommendation #8:**

S&WB Leadership, inclusive of the Board of Directors and senior management, should establish a critical systems maintenance prioritization and tracking system. For example, S&WB should institute an investment and maintenance program that achieves the following: (1) Increases use of uniform inspection protocols and related data-based analysis to establish performance goals for each of the drainage system's drainage pumping stations (DPS) during S&WB/City System design-basis rain storm scenarios, (2) Identifies operational capacity and other resource/asset needs for each DPS to maintain those performance thresholds, (3) Centralizes the ability to assess operational status within the system's pump stations (4) Permanently institutes a fast-track project delivery system and unit to procure, perform and monitor repair and maintenance projects, comparable to what the City and S&WB are using to manage FEMA funded street and subsurface repairs, (5) Trains personnel to use new computerized maintenance management system to centralize and integrate repair and maintenance job creation prioritizing procurement processing, information and workflow tracing and communications across departments and leadership and performance reliability tracking and (6) Standardizes procedures across all drainage pumping stations related to operations, asset inspections, "rain load" event checks, communication protocols and repair and maintenance job requests and project tracking.

**Causal Factors & Root Causes Addressed:**

Causal Factor 4: There were an insufficient number of operable pumps at Drainage Pump Station (DPS) 6 and 7 due to maintenance issues. Specifically, approximately 45% of constructed pumping capacity at DPS 6 and 37% of pumping capacity were out of service during the Loss Event.

Root Cause 4.1: Inadequate Pump Asset Maintenance Planning

Root Cause 4.4: Pump Maintenance was Reactive Rather than Preventative

Causal Factor 6: Pumps were not moving water efficiently due to mechanical integrity issues.

Root Cause 6.1: Inadequate Pump Asset Maintenance Planning

***Recommendation #9:***

Minimum design configuration and operational performance requirements should be established for drainage-dependent pumping and power assets based on realistic goals for minimizing standing water during 5, 10 and 25-year rain events. These goals should be based on modeling of the S&WB/City drainage system as presently designed and configured. Subsequently, S&WB Leadership, inclusive of the Board of Directors and senior management, should set a baseline for minimum 25 Hz power that must be able to be self-generated at any time to achieve the pumping capacity needed to meet those minimized standing water depth aims.

In the interim, S&WB Leadership should consider establishing minimum pump station flow rates required to prevent flooding during various rain event scenarios and determine baseline self-generated power needs to achieve those rates. Further, in lieu of running turbines until failure is imminent and being forced to seek emergency repairs, S&WB Leadership should consider using a more proactive approach to maintenance by establishing clear benchmarks for gauging asset performance health (e.g., functional, problematic, eminent failure, failure) and utilize regular inspections, repairs and related communications to leadership to assure maintenance and repairs occur expeditiously.

***Causal Factors & Root Causes Addressed:***

Causal Factor 5: The drainage pumping system had inadequate design capacity to remove water from drainage basins

Root Cause 5.1: Performance Standards Were Not Established - S&WB operations management did not establish and maintain minimum conditions of operations.

***Recommendation #10:***

New Orleans City Leadership, inclusive of the Department of Public Works; S&WB Board of Directors and senior management and the City Council should develop and implement an integrated (S&WB/City) drainage asset capital improvement strategy to assure that catch basins, minor and major lines, culverts, pumps, related power assets and planned storm water retention projects are designed, scaled in capacity, coordinated in operation and repair and sustainably funded to assure that S&WB/City drainage system can attain the citywide Level of Service recommended in the City's Stormwater Management Capital Improvement Plan – limiting standing water to 6 inches or less amid a 10-year rain event (approximately 8.5 inches over 24 hours).

***Causal Factors & Root Causes Addressed:***

Causal Factor 5: The drainage pumping system had inadequate design capacity to remove water from drainage basins.

Root Cause 5.3: Inadequate Drainage Related Capital Improvement Assessment and Implementation Strategy Relative to Known Physical Environmental Factors within New Orleans Drainage Basins

***Recommendation #11:***

New Orleans City Leadership, inclusive of the Mayor's Office, Chief Administrative Officer, Department of Public Works and the City Council, should institute a more proactive approach to maintaining City

controlled drainage system assets (catch basins, ditches and minor drain lines (under 36-inches)) based on severe rain event performance modeling and inspection data in lieu of the current complaint-driven strategy. Specifically, the following action steps and policies are recommended: (1) Establish a maximum standing water depth goal in each of the City's drainage basins for 5, 10 and 25-year rain events, based on the current design and capacity of the S&WB/City system and the topography and relative imperviousness within each drainage basin; (2) Dedicate sufficient and useable<sup>3</sup> funding to establish a performance baseline aligned with the above performance modeling by video-inspecting and cleaning all of the city's catch basins, ditches and minor drain lines within 3-5 years; (3) Incident to achieving this baseline, annually budget sufficient and useable funding and create policies, procedures and partnerships necessary to maintain the system on par the recommendations of the City's 2011 Stormwater Management Capital Improvement Plan: Annually clean at least 8% of the underground drainage system, including 15% of known problem areas (200 miles of drain lines and 18,250 catch basins); along with video inspecting at least 8% of the underground drainage system (103 miles); (4) Implement enhanced resources for training and retaining personnel along with performance incentives among contracted entities performing inspection and maintenance initiatives; (5) Ensure that monies appropriated for drainage related maintenance do not entail excess regulatory process or limits in use; (6) Require monthly status updates to the City Council and otherwise publicly available detailing progress towards reaching stated inspection and asset clearance goals; and (7) Implement cost-savings policies that reduce barriers to securing equipment, personnel and other resources necessary for meeting maintenance goals such equipment cost-sharing or asset-sharing cooperatives between the City and S&WB as well as neighboring Parish water authorities.

***Causal Factors & Root Causes Addressed:***

Causal Factor 8: Drainage pipes that the City controls and situated with drainage basins impacted by the Loss Events, were clogged or broken.

Root Cause 8.1: Inadequate Long-Term Capital Improvement and Maintenance Planning Based on City Controlled Drainage System Importance and Vulnerabilities

Root Cause 8.2: Inadequate Funding for Departmental Drainage Maintenance and Investment Requests

Root Cause 8.3: Bureaucratic Inefficiencies and Limitations Hamstrung the Ability to More Proactively and Expeditiously Clean Clogged Drain Lines

Causal Factor 9: Catch basins and inlets within the drainage basins impacted by the Loss Events were clogged and broken.

Root Cause 9.1: Inadequate Long-Term Capital Improvement and Maintenance Planning Based on City Controlled Drainage System Importance and Vulnerabilities

Root Cause 9.2: Inadequate Funding for Departmental Drainage Maintenance and Investment Requests

---

<sup>3</sup> Interviews with numerous city officials and an examination of DPW operating budget funding sources since 2011 revealed that while federal grants (FEMA, HUD CDBG, BP settlement monies, etc.) were often appropriated to DPW for drainage related maintenance; in practice city officials believed those grant monies could only be used for capital projects and not for catch basin and drain line clearing.

Root Cause 9.3: Bureaucratic Inefficiencies and Limitations Hamstrung the Ability to More Proactively and Exeditiously Clean Clogged Drain Lines

***Recommendation #12:***

New Orleans City Leadership, inclusive of the Mayor’s Office, Chief Administrative Officer, Department of Public Works and the City Council, should institute a more proactive approach to replacing deteriorated and undersized drainage assets within city control, while investing in increased storm water storage and detention on both public and private property. Specifically, the following action steps and policies are recommended:

Drainage Asset Replacement Measures: (1) Establish a maximum standing water depth goal in each of the City’s drainage basins for 5, 10 and 25-year rain events, based on the current design and capacity of the S&WB/City system and the topography and relative imperviousness within each drainage basin; (2) Based on those performance goals, institute a capital improvement plan with the goal of replacing compromised catch basins and undersize minor drain lines over a ten-year time period; and (3) Integrate drain line replacements into existing “Project Delivery Unit” (PDU) being used to service the \$2.3 billion FEMA-funded surface and subsurface road restoration program. While FEMA funding cannot be used to pay for drainage related improvements<sup>4</sup>, drain line replacements would be done more expeditiously using the more streamlined PDU process.

Capital Investment Funding Measures: In addition to enacting a long-term sustainable funding source for maintenance and capital improvements throughout the S&WB/City drainage system, the following complementing measures are recommended for consideration– (1) Modify existing contracting and procurement rules to allow for “Design-Build-Finance-Maintain” contracting, which could enable public-private funding options for the reconstruction of drain lines as part of adjacent development projects, offsets related to existing storm water retention requirements; or other incentive based partnership structures; (2) Enact a Fee-In-Lieu-Of Charge to developers when major storm water infrastructure improvements are needed to service their development; and (3) Enact an “Availability Charge” to developers or resident to recover their contribution to a storm water control system already constructed with finite capacity.

Stormwater Detention & Storage Investment and Incentives: Consider implementing incentives to reduce stormwater runoff and promote retention including: (1) Link zoning incentives to a fee system to allow higher than normal density if there land is also dedicated for storm water control (i.e., detention, retention, absorption, etc.); (2) Enacting an ordinance and/or executive order establishing a minimum percentage of integrated storm water control related investment among all capital project expenditures between 2018 and 2028; (3) Enact a “green street” ordinance or executive order with specified commitments of total pervious surface area and/or a minimum financial commitment to other storm water control features that are incorporated into street, roadway and curb improvements; and (4) Enact an ordinance and/or executive order that establishes a maximum runoff rate from public property, including parks, parkways and other public spaces.

---

<sup>4</sup> Whereas pre-Katrina inspection data existed for potable water and sewer lines to establish a pre-flood condition baseline by which FEMA was able to award recovery funding for those assets; a lack of reliable pre- and post-Katrina drain line inspection data precluded the award of FEMA funding for rebuilding drain lines.

***Causal Factors & Root Causes Addressed:***

Causal Factor 8: Drainage pipes that the City controls and situated with drainage basins impacted by the Loss Events, were clogged or broken.

Root Cause 8.1: Inadequate Long-Term Capital Improvement and Maintenance Planning Based on City Controlled Drainage System Importance and Vulnerabilities.

Root Cause 8.2: Inadequate Funding for Departmental Drainage Maintenance and Investment Requests.

Root Cause 8.3: Bureaucratic Inefficiencies and Limitations Hamstrung the Ability to More Proactively and Expeditiously Clean Clogged Drain Lines.

Causal Factor 9: Catch basins and inlets within the drainage basins impacted by the Loss Events were clogged and broken.

Root Cause 9.1: Inadequate Long-Term Capital Improvement and Maintenance Planning Based on City Controlled Drainage System Importance and Vulnerabilities

Root Cause 9.2: Inadequate Funding for Departmental Drainage Maintenance and Investment Requests.

Root Cause 9.3: Bureaucratic Inefficiencies and Limitations Hamstrung the Ability to More Proactively and Expeditiously Clean Clogged Drain Lines.

Causal Factor 10: The portion of the drainage system controlled by the City of New Orleans lacked sufficient design drainage capacity, including thousands of miles of drain lines, which the City acknowledges needs to be widened and modernized.

Root Cause 10.1: Inadequate Dedicated Long-Term Funding & Policy Support.

***Recommendation #13:***

Inherent to establishing an integrated drainage system capacity design goal for the S&WB/City asset system (See Recommendation 11), New Orleans City Leadership, inclusive of City agencies and the S&WB Board of Directors and senior management, should also ascertain and communicate the risk of flooding with the city's various drainage basins that will remain within that design capacity goal; determine additional investments and restructuring that would be needed to further reduce such risk; and prepare contingency plans for reducing the risk of human endangerment, property damage, business interruption and compromised transportation mobility during rainfall that exceeds the design capacity of storm water drainage systems.

***Causal Factors & Root Causes Addressed:***

Causal Factor 11: Rainfall in three drainage basins during the Loss Events exceeded the "design storm" capacity of the City controlled portion of the overall drainage system.

Root Cause 11.1: The amount of precipitation that fell during the Loss Event and then migrated to lower lying drainage basins was more volume of water than what the City's total amount of catch basins and minor lines in those areas could store so as to prevent standing waters in excess of 6 inches

Causal Factor 12: Rainfall in four drainage basins during the Loss Event exceeded the “design storm” capacity of the S&WB controlled portion of the overall drainage system.

Root Cause 12.1: The amount of precipitation that fell during the Loss Event and then migrated to lower lying drainage basins was more volume of water than what S&WB’s portion of the drainage system, including fully functioning turbines and pumps, could convey through drain lines to outfall canals to prevent standing waters in excess of 6 inches

***Recommendation #14:***

New Orleans City Leadership, inclusive of S&WB, the Mayor’s Office, Homeland Security and the New City Council, should enact policies and procedures that trigger coordination and communication measures whenever a “rain load” events has been designated by S&WB based on the severity of the anticipated rain event. At a minimum, this designation should entail multi-media communications to the City regarding safeguards for minimizing flood damage to property in the event of standing water beyond system capacity to dewater. Further, the City’s Office of Communication should consider streamlining the protocol for approval of the issuance of public flood advisories.

***Item of Note Addressed:***

The public was not warned in a timely manner about street flooding causing traffic to enter flooded streets. The City Office of Communications procedures prevented NOHSEP personnel from issuing flood advisories to the public without prior approval.

***TURBINE GENERATOR #1 ELECTRICAL FAULT; AUGUST 9, 2017***

On August 9, 2017 at 7:58 PM Turbine Generator # 1 (G1) lost output voltage. This was most likely due to a loss of main G1 field current. Central Control notified Station D to start Frequency Changes #3 and #4 to replace the power lost by the shutdown of G1 since no other 25 Hz turbine generators were operational. Central Control notified the electric shop of the issue. At 9:00 PM, an electrical reported to Central Control that there was a problem with the field rheostat. The Central Control supervisor notified the S&WB Executive Director of the G1 outage because this was the only operable 25 Hz turbine generator at the time.

S&WB electricians found that arcing occurred on the rotating arm which varies the field voltage in manual mode of operation. Arcing destroyed a portion of the rheostat contact plate, rotating arm, wiring and mount board. S&WB maintenance staff fabricated components to replace the failed equipment. Work was completed at 6:00 PM, on August 10. G1 was brought back on line and load was separated from Frequency Changer 4 at 7:03 PM.

The most probable causal factors and associated intermediate causes are:

1. Incorrect wiring of the manual field rheostat due to failure to follow the drawings
2. Inadequate and inconsistent spring force on brushes
3. Misalignment of brushes with contact surfaces caused arcing

Recommendations for immediate action are provided in the report. These are related to checks of the field rheostat to ensure proper wiring and brush system configuration. Recommendations for preventative maintenance are also provided. Root causes developed from the analysis are:

1. Detailed procedures for repair of critical equipment were not developed by S&WB



2. Configuration management for brushes and springs was not maintained

***Recommendations to address root causes:***

Recommendation 1: S&WB should develop procedures for repair of critical equipment that requires adequate testing and independent checks.

Recommendation 2: S&WB should consult with an application's engineer with a reputable brush supplier to develop configuration control for field rheostat equipment to include mechanical, electrical and chemical property.

Recommendation 3: S&WB should prepare preventive maintenance plans for field rheostats.

Recommendation 4: S&WB should consult with brush specialist to determine required brush mechanical, electrical and chemical properties to meet this application.

Recommendation 5: S&WB should periodically check alignment of limit switches.

**Table of Contents**

<b>1. INTRODUCTION .....</b>	<b>30</b>
1.1. THE LOSS EVENT .....	31
1.2. DATA COLLECTION .....	31
1.3. METHODOLOGY .....	32
1.4. CAUSE AND EFFECT TREE .....	32
1.5. TIMELINES .....	34
1.6. ANALYSIS.....	35
<b>2. AGENCIES / FACILITIES / PROCESSES.....</b>	<b>36</b>
2.1. AGENCY RESPONSIBILITIES .....	36
2.2. PUMPS.....	46
2.3. SYSTEM DESIGN STANDARD AND PUMPING CAPACITY .....	51
2.4. POWER GENERATION .....	54
2.5. POWER DISTRIBUTION .....	56
<b>3. DATA COLLECTION .....</b>	<b>58</b>
<b>4. INCIDENT DESCRIPTIONS AND SYSTEM PERFORMANCE SUMMARIES.....</b>	<b>61</b>
4.1. JULY 22, 2017 LOSS EVENT .....	61
4.2. AUGUST 5, 2017 LOSS EVENT .....	62
4.3. DPW SYSTEM PERFORMANCE .....	65
4.4. S&WB PUMPING SYSTEM CAPACITY .....	66
4.5. DRAINAGE PUMPING STATION PERFORMANCE .....	69
4.6. POWER GENERATION SYSTEM PERFORMANCE .....	73
4.7. TURBINE GENERATOR #1 ELECTRICAL FAULT .....	75
<b>5. ANALYSIS.....</b>	<b>81</b>
5.1. RAINFALL.....	81
5.2. FLOODING CLAIMS AND DAMAGE ASSESSMENT .....	86
5.3. S&WB POWER SYSTEMS.....	91
5.4. S&WB PUMPING SYSTEM .....	101
5.5. HYDROLOGIC ASSESSMENT .....	120
5.6. S&WB DRAINAGE SYSTEM FINANCIALS.....	122
5.7. S&WB AND CITY-DPW DRAINAGE SYSTEM GOVERNANCE .....	129
<b>6. CAUSAL FACTORS AND ROOT CAUSES .....</b>	<b>137</b>
6.1. FLOOD EVENTS .....	137
6.2. TURBINE GENERATOR #1 ELECTRICAL FAULT AUGUST 9, 2017.....	148
<b>7. RECOMMENDATIONS.....</b>	<b>151</b>
7.1. FLOOD EVENTS .....	151
7.2. TURBINE GENERATOR #1 ELECTRICAL FAULT .....	156
<b>8. REFERENCES .....</b>	<b>158</b>

**APPENDIX A. TIMELINES**

- A.1 EVENT TIMELINES
- A.2 STORMWATER DRAINAGE SYSTEM TIMELINE
- A.3 DPS PUMP STATUS TIMELINES

**APPENDIX B. CAUSE AND EFFECT TREES**

- B.1 HIGH LEVEL CAET FOR FLOOD EVENT
- B.2 DETAILED LEVEL CAET FOR FLOOD EVENT (PARTIAL)
- B.3 CAET FOR TURBINE GENERATOR #1 ELECTRICAL FAULT
- B.4 DETAILED LEVEL CAET FOR FLOOD EVENT

**APPENDIX C. RAINFALL**

- C.1 RAINFALL MAPS
- C.2 RAINFALL RECURRENCE INTERVALS AND PPE

**APPENDIX D. FLOOD DAMAGE ASSESSMENT**

- D.1 911 CALLS
- D.2 FLOODING CLAIMS
- D.3 DAMAGE ASSESSMENT

**APPENDIX E. S&WB POWER SYSTEM ANALYSIS**

- E.1 POWER GENERATED
- E.2 POWER PURCHASED FROM ENTERGY
- E.3 DENIED PUMPS
- E.4 ESTIMATED POWER GENERATED & POWER CONSUMPTION
- E.5 POWER DISTRIBUTION ROUTES

**APPENDIX F. S&WB PUMPING SYSTEM ANALYSIS**

- F.1 SUCTION BASIN CAPACITY FOR JULY 22 AND AUGUST 5/17
- F.2 SUCTION BASIN DEPTH AND PUMPING % AUGUST 5
- F.3 PUMP STATION OPERATION SUMMARIES AUGUST 5

**APPENDIX G. DPW CATCH BASIN CLEANING**

- G.1 DPW DRAINAGE SYSTEM NETWORK
- G.2 DPW CATCH BASIN CONDITION

**APPENDIX H. S&WB FINANCIAL ANALYSIS**

**APPENDIX I. DRAINAGE BASINS**

**APPENDIX J. DATA REQUEST LOG**

**APPENDIX K. S&WB ORGANIZATIONAL CHARTS**

**LIST OF TABLES**

TABLE 1. PUMP ASSETS OF OLD CITY DRAINAGE PUMPING STATIONS.....	47
TABLE 2 PUMPS NOT IN SERVICE JULY 22 AND AUGUST 5 .....	49
TABLE 3. PRECIPITATION DEPTH – DURATION FREQUENCY ESTIMATES.....	52
TABLE 4. PUMPING CAPACITIES DRAINAGE PUMPING STATION IN THE OLD CITY.....	53
TABLE 5. S&WB 25 Hz POWER GENERATION ASSET STATUS .....	55
TABLE 6. S&WB 60 Hz POWER GENERATION ASSETS DURING LOSS EVENTS .....	56
TABLE 7. FLOOD RELATED 911 CALLS.....	63
TABLE 8. TARGET AND INSTALLED PUMPING CAPACITY FOR DRAINAGE PUMPING STATIONS.....	67
TABLE 9. DPS OPERATIONAL CAPACITY VS. TARGET CAPACITY .....	68
TABLE 10. MAXIMUM PUMPING CAPACITY USED .....	69
TABLE 11 PUMP START REFUSALS .....	74
TABLE 12 SHOP TICKETS FOR TURBINE GENERATOR #1 FIELD RHEOSTAT.....	80
TABLE 13 WORK ORDERS FOR TURBINE GENERATOR #1 FIELD RHEOSTAT .....	80
TABLE 14 JULY 22 RAINFALL.....	81
TABLE 15 AUGUST 5 AVERAGE RAINFALL BY DRAINAGE BASIN .....	82
TABLE 16 AUGUST 5 AVERAGE RAINFALL AND RECURRRECE INTERVALS .....	82
TABLE 17 RECURRRECE INTERVALS AND PRECIPITATION FREQUENCY ESTIMATES FOR AUGUST 5 EVENT .....	83
TABLE 18 911 CALLS .....	86
TABLE 19 NUMBER OF NFIP FLOOD CLAIMS .....	89
TABLE 20 PUMP START DENIALS .....	96
TABLE 21 POWER GENERATION AND CONSUMPTION (kW) JULY 22, 2017.....	97
TABLE 22 POWER GENERATION (MW) AUGUST 5, 2017.....	97
TABLE 23 LONG TERM EQUIPMENT FAILURES UNADDRESSED BY AUG. 5 .....	119
TABLE 24 CAUSAL FACTORS, ROOT CAUSES AND RECOMMENDATION FOR FLOOD LOSS EVENTS .....	137
TABLE 25 CAUSAL FACTORS, ROOT CAUSES AND RECOMMENDATION FOR TURBINE GENERATOR 1 ELECTRICAL FAULT.....	149

**LIST OF FIGURES**

FIGURE 1 "OLD CITY" DRAINAGE BASINS .....	30
FIGURE 2 HIGH LEVEL CAUSE AND EFFECT TREE.....	33
FIGURE 3 DETAILED CAUSE AND EFFECT TREE (PARTIAL) .....	34
FIGURE 4 TIMELINE FOR AUGUST 5-6, 2017 FLOODING .....	35
FIGURE 5 S&WB ORGANIZATIONAL STRUCTURE - AUGUST 5, 2017.....	37
FIGURE 6 CATCH BASIN CLOGGING .....	39
FIGURE 7 CATCH BASIN CONDITION AS OF AUGUST 5 .....	40
FIGURE 8 DPW DRAINAGE NETWORK.....	41
FIGURE 9 "HOTSPOT" DENSITY (<15-IN DIAMETER PIPES) IN THE OLD CITY .....	41
FIGURE 10 DRAINAGE BASINS IN THE OLD CITY .....	43
FIGURE 11 DRAINAGE PUMPING STATIONS AND DISCHARGE PATHS .....	46
FIGURE 12 TYPICAL DRAINAGE PUMPING STATION .....	50
FIGURE 13 911 CALL DENSITY DISTRIBUTION .....	63
FIGURE 14 DRAINAGE PUMPING STATION 3 PERFORMANCE TIMELINE.....	70
FIGURE 15 LOCATION OF FIELD RHEOSTAT .....	75
FIGURE 16 DAMAGE TO FIELD RHEOSTAT.....	76
FIGURE 17 ONE-LINE DIAGRAM FOR FIELD RHEOSTAT .....	78
FIGURE 18 ONE LINE DIAGRAM WITH INCORRECT WIRING FOR FIELD RHEOSTAT .....	78
FIGURE 19 FIELD RHEOSTAT DAMAGE AUGUST 9, 2017.....	79

FIGURE 20 AVERAGE RAINFALL BY DRAINAGE BASIN AUGUST 5 ..... 84

FIGURE 21 AVERAGE RECURRENCE INTERVAL (NWS) 3 HOURS AUGUST 5..... 84

FIGURE 22 911 CALLS JULY 22 ..... 87

FIGURE 23 911 CALLS AUGUST 5 ..... 87

FIGURE 24 NOHSEP LOOD DAMAGE ASSESSMENT AUGUST 5 EVENT ..... 88

FIGURE 25 NFIP CLAIMS DISTRIBUTION ..... 89

FIGURE 26 LOCATION OF FLOODING NEAR PEOPLES AVENUE CANAL ..... 90

FIGURE 27 DRAINAGE STATION FEEDER NETWORK ..... 92

FIGURE 28 POWER SCHEMATIC FOR 60 HZ ENTERGY POWER SUPPLY ..... 93

FIGURE 29 25 HZ POWER PRODUCTION FROM S&WB TURBINE GENERATORS 2011-2017 ..... 95

FIGURE 30 25 HZ POWER USED BY PUMPS AND POWER CAPACITY ON AUGUST 5, 2017 ..... 98

FIGURE 31 25 HZ POWER DEMAND VS CAPACITY ..... 99

FIGURE 32 POWER PRODUCTION BY S&WB TURBINE GENERATORS(KWH) ..... 100

FIGURE 33 ENTERGY POWER USAGE BY S&WB DRAINAGE ..... 100

FIGURE 34 DPS 7 PUMPING - % OF OPERATIONAL CAPACITY ..... 101

FIGURE 35 DPS 7 PUMPING - % OF INSTALLED CAPACITY ..... 102

FIGURE 36 DRAINAGE BASIN BOUNDARIES AND AVERAGE RAINFALL ..... 102

FIGURE 37 DPS 1 SUCTION BASIN LEVELS AUGUST 5 ..... 103

FIGURE 38 DPS 1 PUMPING PERFORMANCE AUGUST 5 ..... 104

FIGURE 39 DPS 2 SUCTION BASIN LEVELS AUGUST 5 ..... 105

FIGURE 40 DPS 2 PUMPING SYSTEM PERFORMANCE AUGUST 5 ..... 105

FIGURE 41 DPS 3 SUCTION BASIN LEVELS AUGUST 5 ..... 106

FIGURE 42 DPS 3 PUMPING SYSTEM PERFORMANCE AUGUST 5 ..... 107

FIGURE 43 DPS 4 SUCTION BASIN LEVELS AUGUST 5 ..... 108

FIGURE 44 DPS 4 PUMPING SYSTEM PERFORMANCE AUGUST 5 ..... 108

FIGURE 45 DPS 6 SUCTION BASIN LEVELS AUGUST 5 ..... 110

FIGURE 46 DPS 6 PUMPING SYSTEM PERFORMANCE AUGUST 5 – AVAILABLE ..... 110

FIGURE 47 DPS 6 PUMPING SYSTEM PERFORMANCE AUGUST 5 – INSTALLED CAPACITY ..... 111

FIGURE 48 DPS 7 SUCTION BASIN LEVELS AUGUST 5 ..... 112

FIGURE 49 DPS 7 PUMPING SYSTEM PERFORMANCE AUGUST 5 - AVAILABLE ..... 112

FIGURE 50 DPS 7 PUMPING SYSTEM PERFORMANCE AUGUST 5 - CAPACITY ..... 113

FIGURE 51 DPS 12 SUCTION BASIN LEVELS AUGUST 5 ..... 114

FIGURE 52 DPS 12 PUMPING SYSTEM PERFORMANCE AUGUST 5 ..... 114

FIGURE 53 DPS 19 SUCTION BASIN LEVELS AUGUST 5 ..... 115

FIGURE 54 DPS 19 PUMPING SYSTEM PERFORMANCE AUGUST 5 ..... 116

FIGURE 55 PREDICTED FLOODING IN DB 3 FOR 10-YEAR STORM..... 121

FIGURE 56 PREDICTED FLOODING IN DB 3 FOR 100-YEAR STORM..... 121

FIGURE 57 2016 BUDGET PRIORITIES - PUMPS..... 125

FIGURE 58 2017 BUDGET PRIORITIES - PUMPS..... 126

FIGURE 59 UNSPENT BUDGET FOR CAPITAL IMPROVEMENT ..... 127

FIGURE 60 CAUSE AND EFFECT TREE FOR TURBINE GENERATOR 1 ELECTRICAL FAULT ..... 148

## 1. INTRODUCTION

Severe rainstorms, which occurred in Orleans Parish in July and August of 2017, created unexpected street and structure flooding over much of the “Old City” (Figure 1). The severity of flooding was exacerbated by compromised performance of the storm water drainage system. Conflicting information was provided by Sewerage and Water Board (S&WB) during and after the events regarding performance of pumping equipment including which assets of S&WB were operational and how effectively they were working to remove flood waters.



**Figure 1 "Old City" Drainage Basins**

An electrical fault occurred on August 9 in the Turbine Generator #1 at the S&WB Carrollton plant which disabled the only operational 25 Hz turbine generator at the time. This left the city vulnerable to flooding with any significant rainfall. The turbine generator was repaired and resumed operation within 24 hours, but pumping system reliability was severely reduced.

In January of 2018, ABS Group was contracted by the City of New Orleans to conduct a root cause analysis of the flooding which occurred on July 22, August 5th and August 8, 2017 as well as the turbine generator electrical fault which occurred on August 9, 2017. ABS Group was supported in this work by GAEA Consultants and Carra Stone LLP, both of New Orleans.

### **1.1. THE LOSS EVENT**

The first step in the analysis was to determine the Loss Event. The City's Stormwater Management Capital Improvement Plan ("Stormwater Plan") defines an acceptable Level of Service (LOS) as no more than 6 inches of storm water above roadways for a 10-year rainfall frequency (8.5 inches of rainfall over 24 hours). It is important to note that the city's whole drainage system (inclusive of S&WB and City assets) has not historically been designed in an integrated manner to achieve this recommended 10-year rainfall LOS goal.<sup>5</sup> Nonetheless, because the 10-year LOS was recommended as the minimum design standard within the city's Stormwater Plan and is increasingly guiding S&WB and city capital and design improvements, the 10-year rainfall LOS was used as the benchmark by which to define the flood related Loss Events as flooding in excess of 6 inches of standing water over the duration of the rain events.

The often-cited drainage pump flow rate of pumping one-inch of surface water that enters into the drainage system within the first hour of a rain event and one-half inch thereafter was not used as the benchmark for defining the flood related Loss Events given its more narrow focus. This standard is a gauge of pumping and power asset performance relative to surface waters that can enter into system. We have referred to this flow rate as the Target Capacity since this is the target that S&WB seek to achieve. The standard does not account for design and performance goals relative to catch basins, drain lines and culverts by which rainfall enters into the system and is conveyed to the pump stations. Above all, this flow rate standard does not reflect desired standing water outcomes. Indeed, interviewed S&WB signaled their belief that S&WB pump and power assets were able to realize the one-inch/half-inch flow rate during the July and August Loss Events. Analysis indicates they system provided 80% to more than 2.8 times this flow rate. This underscores the inadequacy of using this flow rate standard as a baseline design LOS by which to gauge the severity of the Loss Events flooding.

### **1.2. DATA COLLECTION**

Our root cause investigation began with a wide-ranging data collection effort which included operational performance, maintenance and capital improvement, staffing data for S&WB pumping, drainage and power systems. Maintenance policies and maintenance management systems information was also collected. S&WB Board of Directors meeting minutes and information packets provided to the Board by S&WB management were reviewed. Inspections were conducted at selected pumping discharge stations, Central Control, as well as frequency changers, boilers and turbines in the Carrollton plant.

We also collected condition information on the City's Department of Public Works (DPW) storm water drainage structures including catch basins and piping as well as funding sources and contracts for repair of these assets. Information prepared by the New Orleans Department of Homeland Security and Emergency Preparedness was reviewed including damage assessments, flood claim data and communication actions during the event.

---

<sup>5</sup> Individual portions of the system such as the recent expansion of underground culverts and any new drain lines to be installed under streets are designed for the recommended LOS; however, the system as a whole is not the outcome of an integrated design towards this LOS goal.

Interviews with key personnel were also conducted to understand equipment and personnel performance gaps. These interviews included discussions of contributing factors and root causes such as management systems and resources.

### **1.3. METHODOLOGY**

The RCA investigates the proximate causes (i.e., equipment performance gaps and front-line personnel performance gaps) contributing to the flooding on the identified dates in the summer of 2017 (the Loss Event). We refer to these performance gaps as causal factors (CF). Once these causal factors are identified, factors contributing the performance gaps are developed through analysis of the data and interviews with personnel. These contributing factors are referred to as intermediate causes and typically include performance gaps in design, maintenance, documentation, materials/parts, hazard/defect identification, procedures, human factors, training, supervision, communication, personnel performance and external factors. Root causes are deficiencies in management systems that allow causal factors to occur or exist.

The flood events, which are the subject of this study, had similar causes but differing levels of severity. The August 5 event was by far the most damaging of the floods due to the highest level of rainfall and pervasive issues with pumping system performance. The analysis thus focused on this event for detailed analysis of the interplay between the various causes.

### **1.4. CAUSE AND EFFECT TREE**

One analysis technique used for evaluation of the flooding incidents was a Cause and Effect Tree (CAET). This technique lays out the causal and intermediate factors on a logic tree which identifies the collection of factors which may be responsible for the Loss Event. A high level CAET for these events is shown in Figure 2. The box colors indicate the plausibility that cause listed in the box contributed to the Loss Event. More complex CAETs were developed for each drainage basin in Orleans Parish to determine which cause were applicable in each basin. These more detailed CAETs considered a wide range of potential contributing causes including equipment failures, personnel performance failures and management systems failures. A portion of the detailed CAET is shown in Figure 3. The complete detailed CAET is included in Appendix B.



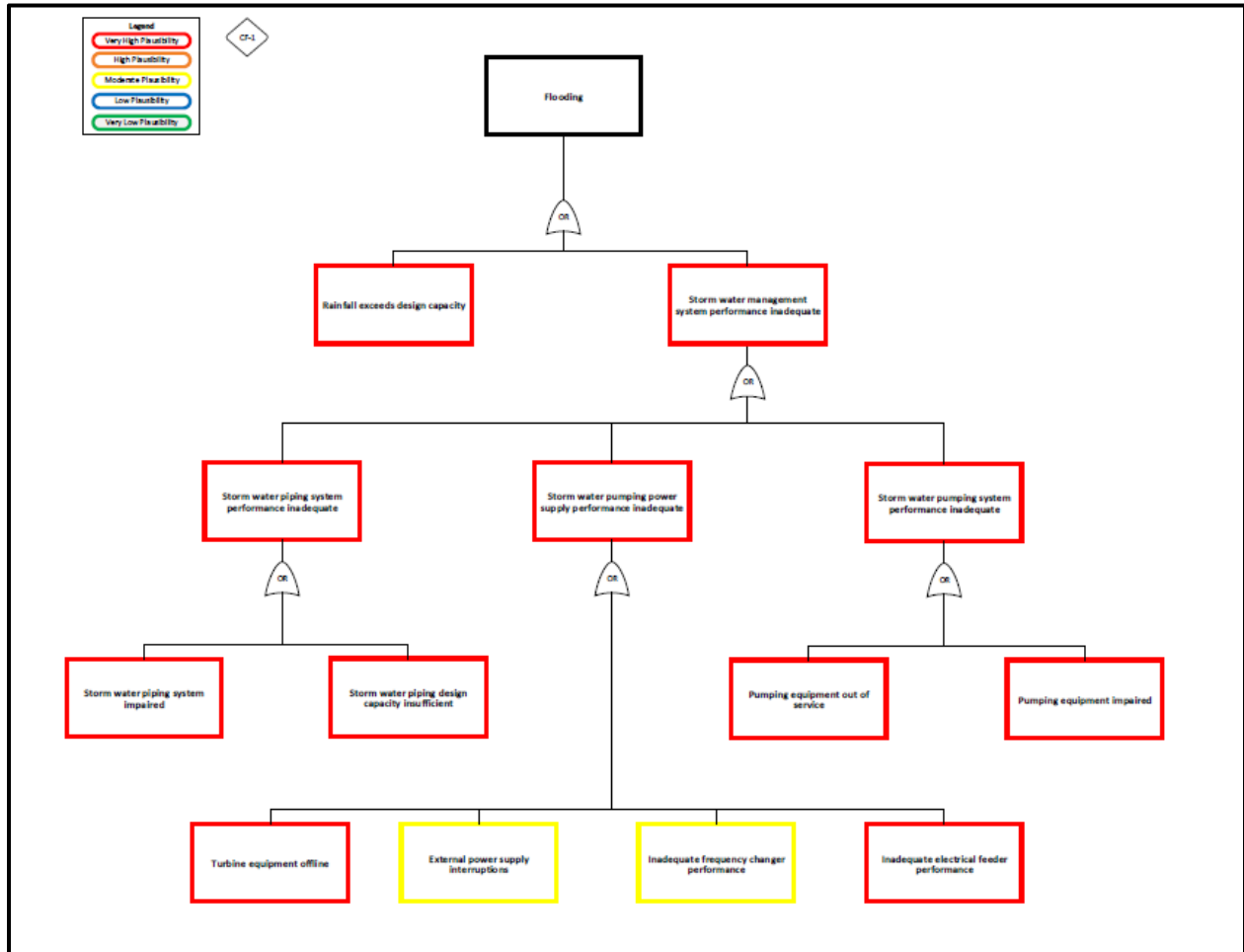
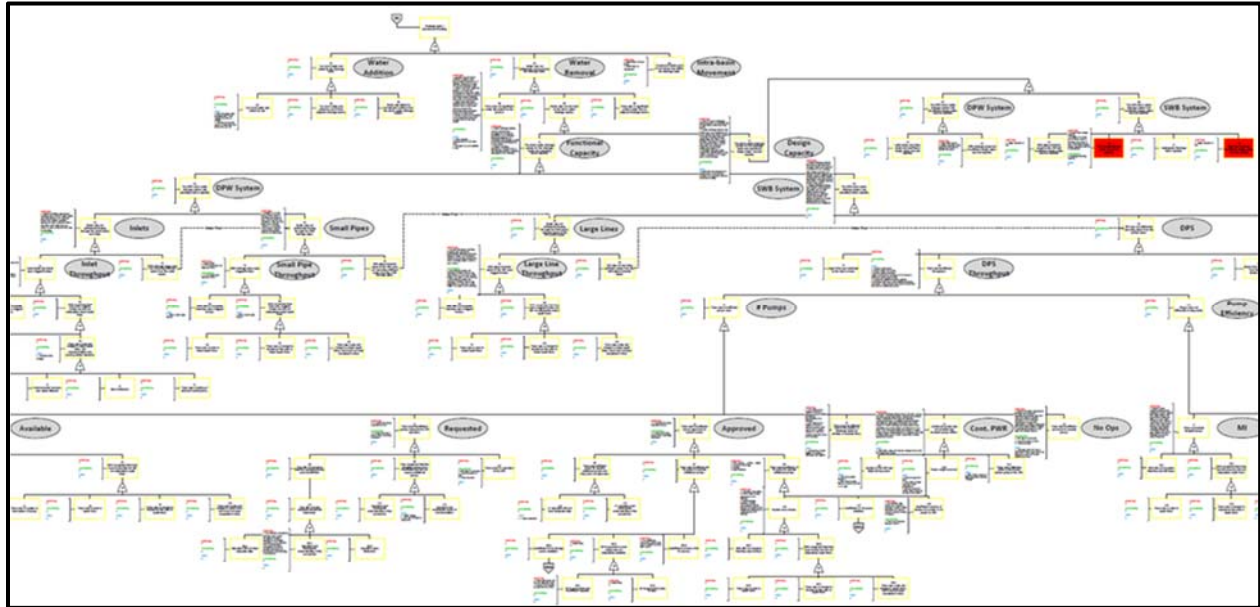

Figure 2 High Level Cause and Effect Tree



**Figure 3 Detailed Cause and Effect Tree (Partial)**

Any cause tied to an effect through an OR gates in the CAET must be mitigated to eliminate the effect. To eliminate flooding, both excessive rainfall and inadequate drainage system performance must be solved. Since control of rainfall is not possible, rainfall which exceeds the design basis storm will result in flooding. This risk must be accepted, or the design basis storm must be changed to a greater storm frequency and associated increased rain intensity. Improvements in the storm water drainage system will reduce but not eliminate flooding for the rainfall which occurred on August 5.

### **1.5. TIMELINES**

The second technique used in the RCA is an event timeline. The Loss Events are extremely dynamic, and the sequence of events is complex. The timeline establishes the temporal relationships of equipment and personnel and is important to understand the causes for the flood Loss Event.

Timelines for the day of the loss events is shown in Appendix A.1 for July 22, August 5 and August 8. The August 5 timeline is shown in Figure 4. Additional timelines were also constructed to provide visibility to the events. The first was a macro timeline which identifies key events and actions occurring prior to the flooding which contribute to the loss. This timeline is found in Appendix A.2. It is helpful to show how decisions affect long term performance of systems and why it is critical to implement corrective actions to prevent future losses. As seen in the timeline in Appendix A.2, decisions 20 or more years ago contributed to the Loss Events in the summer of 2017.

A third type of timeline captures detailed activity at the drainage pumping stations which occur on or immediately before the Loss Events. Pumping and power equipment (turbines, frequency changers, generators, Entergy supply) and staffing status are captured in the events micro timeline developed from operator logs. These timelines, shown in Appendix A.3, are used to compare actual equipment usage with pumping needs to identify the source of pumping deficiencies.



## 2. AGENCIES / FACILITIES / PROCESSES

### 2.1. AGENCY RESPONSIBILITIES

#### 2.1.1. S&WB

##### *The Sewerage and Water Board Within the Structure of City Government*

In 1903, Louisiana state statute and the New Orleans City Charter made the New Orleans Sewerage and Water Board (S&WB) the single agency responsible for construction, operation and maintenance of the major drainage system, sanitary sewerage and drinking water supply for the City of New Orleans. A 1992 Cooperative Endeavor Agreement between the City and S&WB established division of responsibility for the storm water drainage system. Street drainage and the minor drainage network is the responsibility of the City of New Orleans Department of Public Works (DPW). The division of responsibility for drainage between the S&WB and the DPW has existed since the organization of both agencies.

Since its inception, the broad majority of the S&WB has been appointed by the Mayor. Prior to 2014, the S&WB consisted of the Mayor, two at-large members of the City Council, one district councilman selected by the Council, two members of the Board of Liquidation and seven citizen members appointed by the Mayor, for overlapping terms of 9 years.

In January 2014, state legislation reduced the S&WB board of directors from 13 to 11 members and limited board member terms to two consecutive four-year terms. Sitting City Council members were eliminated, and mayoral appointments increased from seven board members to eight. As of 2017, the Board of Directors consisted of: the Mayor; two members of the Board of Liquidation; and eight citizen members, of which five represent City Council districts, one at-large representative and two consumer advocates.

In August 2014, the City of New Orleans and the S&WB signed a cooperative endeavor agreement creating the position of Executive Director of the S&WB serving at the pleasure of the Mayor. Mayor Landrieu appointed the Deputy Mayor for facilities, infrastructure and community development as Executive Director of the S&WB (Cedric Grant).

##### *Responsibilities of S&WB*

The S&WB is responsible for the following utilities within the City of New Orleans:

- Planning, operations and maintenance of large drainage network and drainage pumping.
- Planning, operations and maintenance of sanitary sewer and drinking water systems.
- Planning, operations and maintenance of power generation and distribution for all three utility systems.

*S&WB Organization Structure*

The S&WB consists of the appointed board, executive leadership serving at the pleasure of the Mayor or the Board, Civil Service unclassified professional staff and classified staff. The organization structure of the S&WB leadership as of August 05, 2017 is reflected in Figure 5.

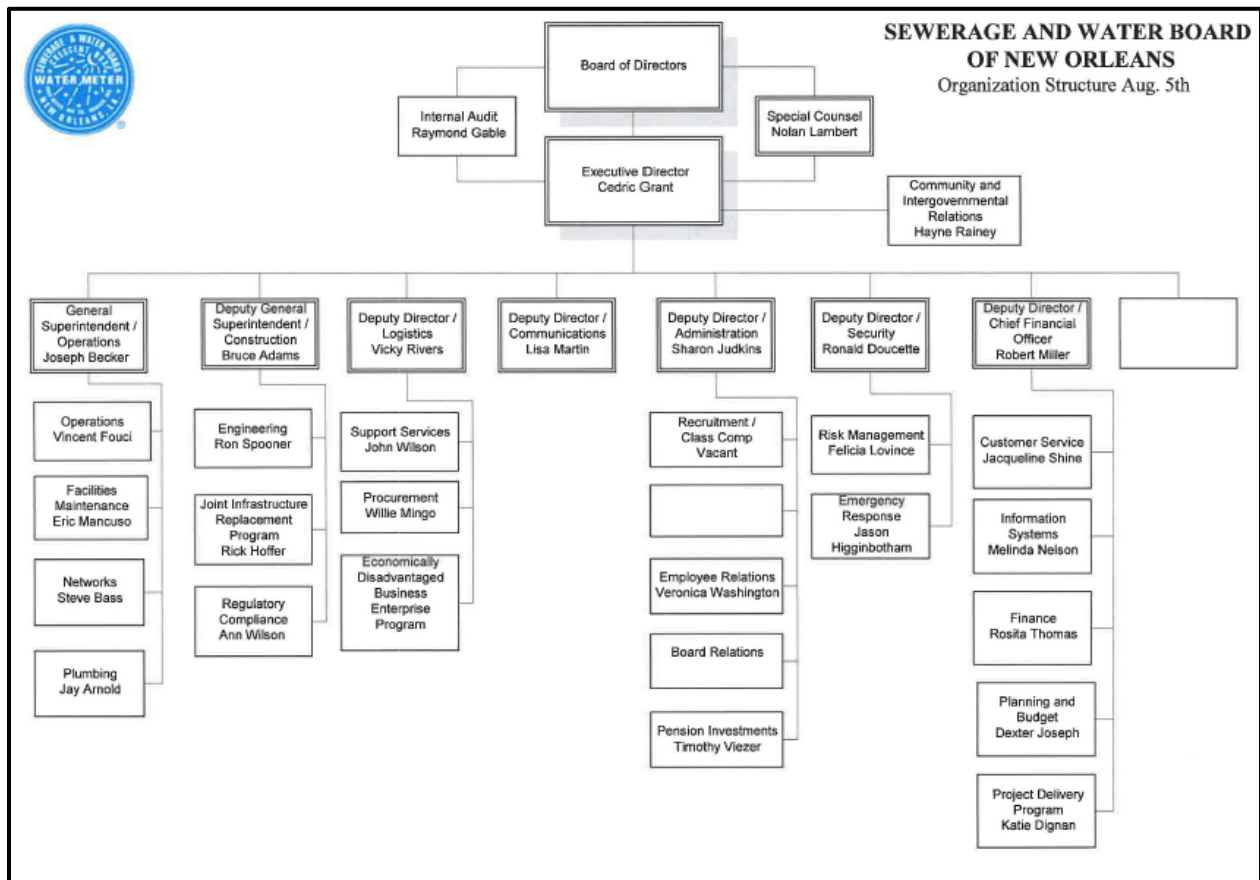

**Figure 5 S&WB Organizational Structure - August 5, 2017**

\* As provided by S&WB

The Sewerage and Water Board Emergency Management Department oversees emergency operations related to external situations that affect normal internal S&WB operations. The department reports to the Deputy Director of Security. The different responsibilities that fall under the umbrella of the Emergency Management Department are:

- Emergency Preparedness
- Emergency Prevention
- Emergency Response
- Recovery
- Mitigation

The Emergency Management Department does not make drainage operations (i.e., pumping) decisions during rain events.

### **2.1.2. CITY OF NEW ORLEANS, DEPARTMENT OF PUBLIC WORKS**

In terms of municipal drainage, the City of New Orleans is ultimately responsible for the public's interest and safety for life and property. The City government, through its representation on the S&WB, is responsible for the prioritization of capital projects and allocation of funding for drainage operations. It is also the responsibility of the City mayoral administration and City Council to provide leadership in acquiring funding for drainage operations and improvements, either through collection and disbursement of dedicated taxation or through the acquisition of grants or other aid, including aid from the federal government.

The New Orleans Office of Homeland Security and Emergency Preparedness (NOHSEP) is the coordinating public safety agency for the City of New Orleans. The office is responsible for hazardous weather response plans, urban search and rescue and other emergency functions.

The City has a consolidated 911 system of operators and dispatchers for the police, fire and emergency medical service departments. The City 311 system processes requests for information and for specific non-emergency city services, including pothole, subsidence and road shoulder repairs on city-owned streets and drainage issues such as catch basins, culverts, ditches and manhole covers (DPW drainage system only).

The City of New Orleans coordinates with the S&WB Emergency Management Department (discussed below). City of New Orleans agencies other than the S&WB do not make drainage operations (i.e. pumping) decisions during rain events.

### **2.1.3. DPW SYSTEM**

DPW is a City department under a mayoral-appointed Director who as of summer 2017 reported to the Deputy Mayor for facilities, infrastructure and community development (Cedric Grant, also Director of the S&WB). DPW is responsible for maintaining city streets, including paving streetlights and signage, parking, traffic cameras and permits. DPW is also responsible for planning, operations and maintenance of street drainage and the small drainage network. The Louisiana Department of Transportation and Development is responsible for maintaining an additional 105 miles of state and federal highways within the City limits.

Street drainage is affected by the surface condition of streets and for an indefinite period preceding summer 2017, DPW was operating with a backlog of maintenance repairs to potholes, pavement caves, etc. Approximately 15 percent of street length in the City is without subsurface drainage and relies on surface drainage to ditches, swales or alleys for precipitation to run off to adjacent streets with subsurface drainage. In the summer 2017, DPW was operating with a backlog of ditch and grade maintenance.

The DPW drainage network has approximately 65,000 catch basins city-wide (East and West banks). In the summer of 2017 DPW was operating with a backlog of catch basin maintenance and repair. The Veolia Condition Assessment (2017-2018) estimated from a 1 percent sample that the catch basin network, as a whole, had 16 percent diminished capacity.

In 2010, CDM Smith completed the City of New Orleans Stormwater Management Capital Improvements Plan, which called for cleaning all catch basins in the City on a nine-year schedule of 7,000 to 8,000 basins per year.

Prior to 2011, very few catch basins were being cleaned and repaired annually due to DPW budget and staff shortages. Following Hurricane Isaac (2012), a program was proposed to clean 13,000 catch basins. Actual cleaning rate was 2,100 basins in 2012 rising to 7,600 in 2015, with target cleaning reduction to 4,500 in 2016 (with increased inspection). The 2017 cleaning target was 4,500 basins. DPW unclogged 3,272 catch basins between January 1 and August 5, 2017. As of July 2017, there were 2,700 citizen-generated requests backlogged for catch basin cleaning.

Figure 6 indicates distribution of clogged catch basins in the Old City. Figure 7, provided by DPW, shows the condition status of catch basins at the time of flooding on August 5.

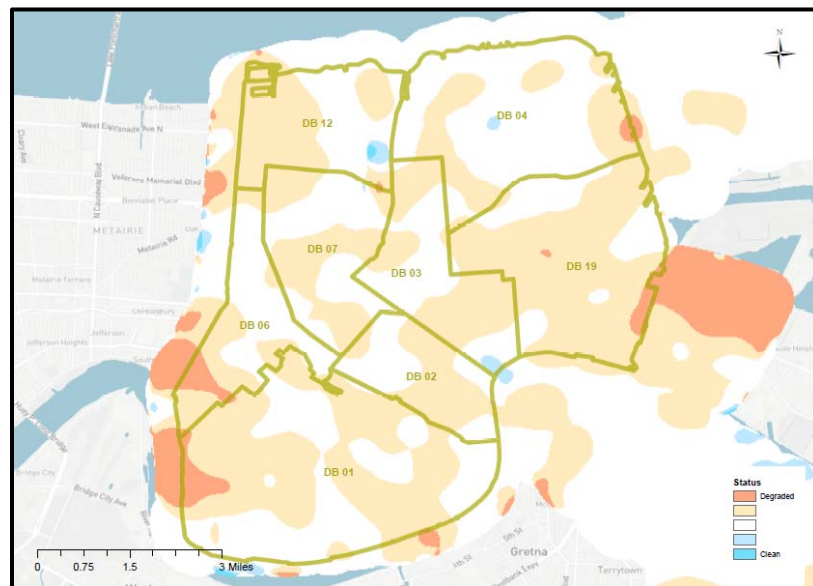

**Figure 6 Catch Basin Clogging**

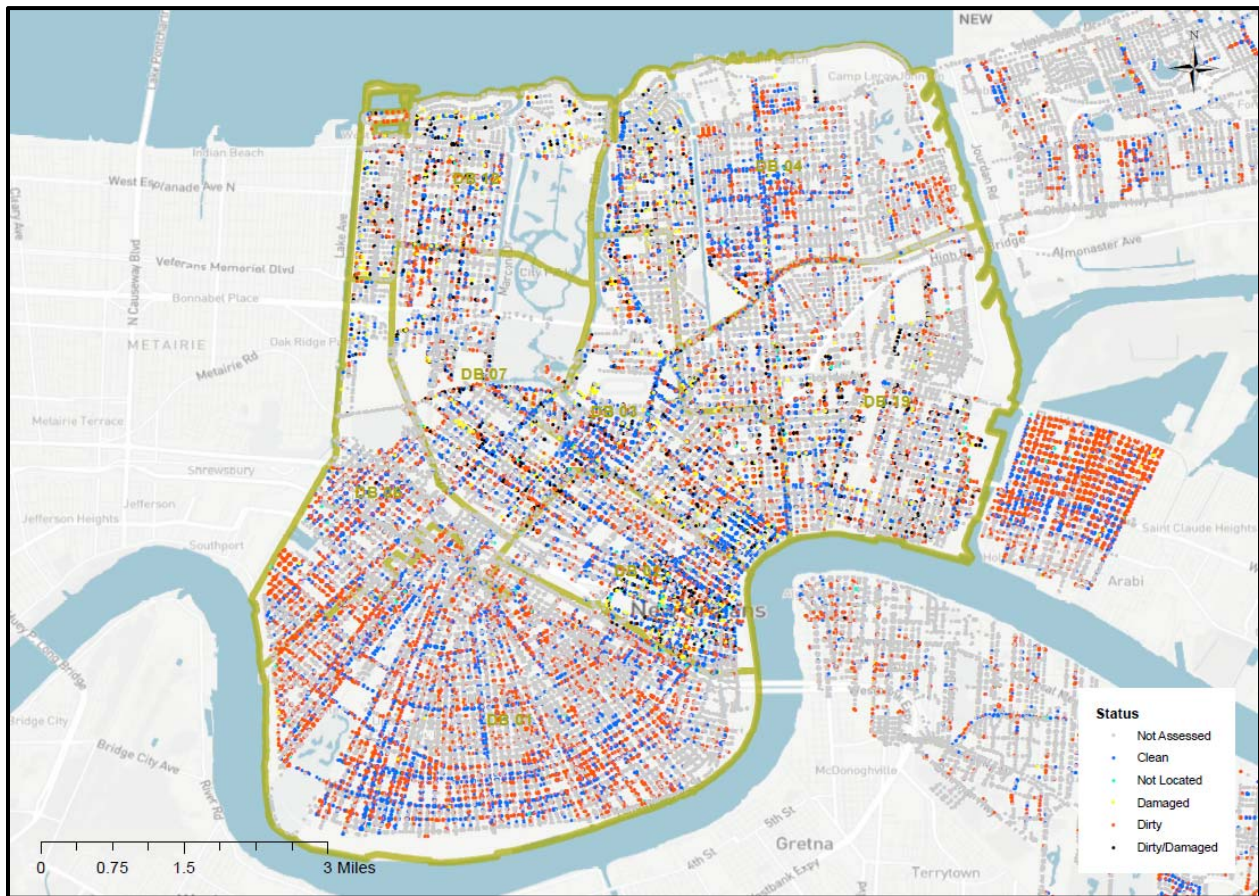

**Figure 7 Catch Basin Condition as of August 5**

The DPW network has approximately 8.2 million linear feet of small drainage pipe network (<36" diameter) city-wide (East and West banks).

System design standard - Construction of the contemporary street drainage system in New Orleans began more than 100 years ago with engineering standards different than the present day. Many drain lines remain in place that are considered undersized under a current local "10-yr storm" level of service (LOS) expectation. In New Orleans, minimum street drainage design pipe size is now 15-in. As a consequence of historic development, much of the street drainage in the Old City is undersized. The proportion of undersized pipes corresponds approximately to the age of general development of the neighborhood.

Figure 8 shows distribution of drainage pipe sizes in the Old City. Figure 9 provides a visualization of small pipe "hot spots" or areas where undersized drainage pipes (less than 15-in diameter) are concentrated. The Veolia Condition Assessment (2017-2018) estimated from a 1 percent sample that the pipe network had 27 percent diminished capacity.



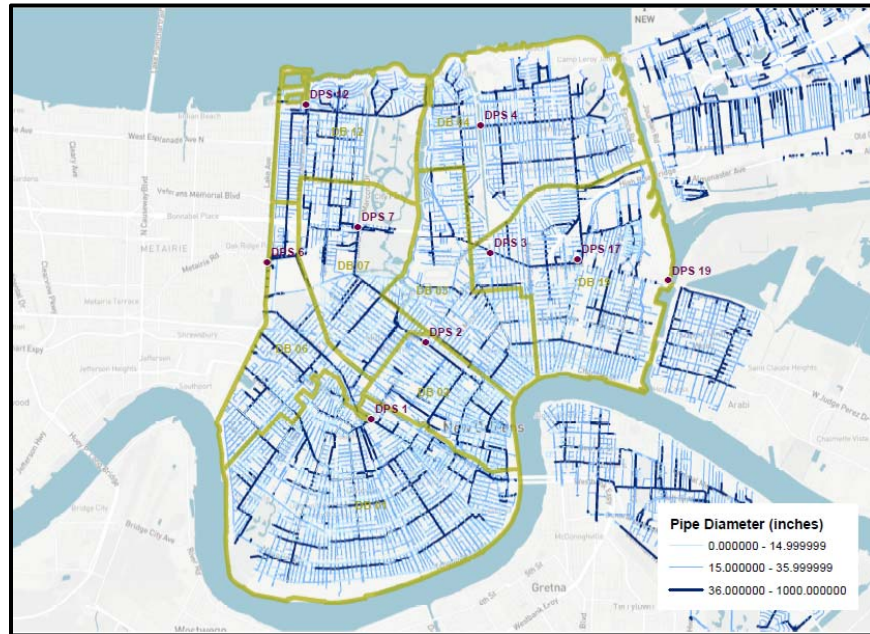

**Figure 8 DPW Drainage Network**

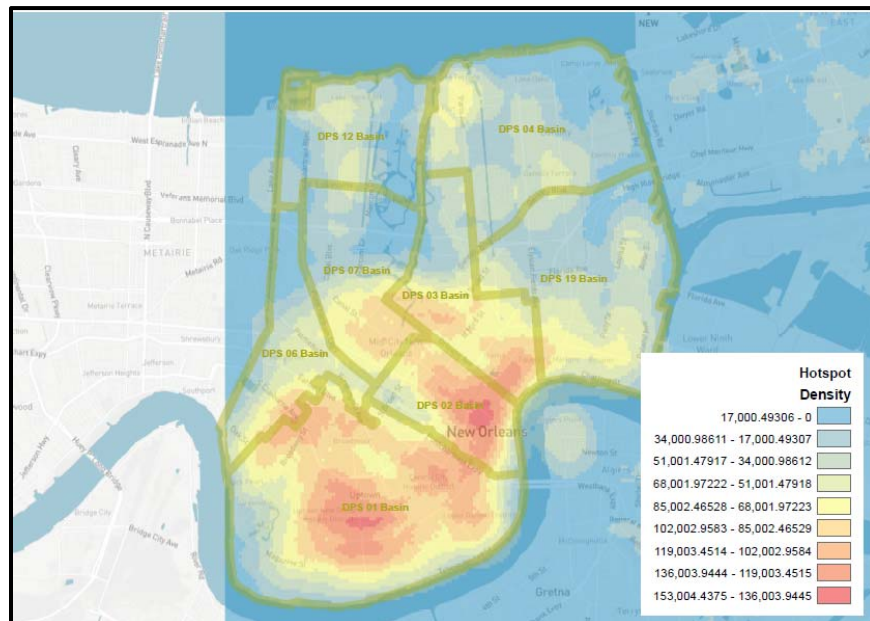

**Figure 9 "Hotspot" Density (<15-in Diameter Pipes) in the Old City**

**Subsidence** - The entirety of the Louisiana Deltaic Plain in which Orleans parish is subsiding or losing elevation, for a number of complex and interrelated reasons. A very approximate estimate for subsidence of the Old City area since 1900 is:

- From the River to the Bayou Metairie and Bayou Gentilly natural levees, most of the ground surface has sunk very approximately 2-3 feet during the last century. Large portions of the Old City remain above sea level.

- In the former marshes between the natural levees and Lake Pontchartrain, the ground surface has sunk during the last century from near sea level to anywhere from several feet to 8 feet or more below sea level.

Recent studies of subsidence in New Orleans have most of the Old City area subsiding at a rate of 0.1 – 0.3-in/yr., with some spots subsiding 0.8-in/yr., with variations.

The consequences of subsidence to this degree and at these rates include alteration in grade of gravity drainage features. For example, a street drainage pipe may subside such that its outlet into the drainage network is at a higher elevation than its inlet, preventing water from flowing out of the pipe or even off the street. This situation presents a continual maintenance, repair and reconstruction challenge for the drainage network.

#### **2.1.4. S&WB NETWORK**

The “Old City” of New Orleans constitutes a single polder or area surrounded by levees from which precipitation, other than that absorbed by the ground, must be removed by pumping. If it were not pumped out, the majority of rainfall would simply fill in water bodies within the polder and inundate the ground. The Old City is circumscribed by:

The Mississippi River mainline levees

The upper protection levee following the Jefferson Parish/Orleans Parish boundary

The Lake Pontchartrain levees

The Industrial Canal levees

There are no uncontrolled drainage outlets from the Old City into the Mississippi River, Lake Pontchartrain, or the Industrial Canal

The S&WB drainage pumping stations (DPS) are located at various points in the drainage network, which is divided into eight drainage basins (DB) by the functional design of the drainage system. Boundaries of the drainage basins, shown in Figure 10, are sometimes based on natural topographic features (such as natural levee ridges) and sometimes on other hydraulic or physical considerations (e.g. historic elevated railroad alignments or highways). Drainage basins are not based on neighborhoods, Wards, Planning Districts, City Council Districts, Police Districts or any subdivision for another purpose.



**Figure 10 Drainage Basins in the Old City**

Drainage Basin 1 (approximately 5540 acres)

Topography of DB 1 slopes down from the Mississippi River northward toward DB 6 and DB 2. DB 1 receives little natural runoff from adjacent basins. DB 1 is drained by DPS 1.

DB 1 generally corresponds to neighborhoods constituting the Uptown, Central City and Garden District areas of the City.

Drainage Basin 2 (approximately 1610 acres)

Topography of DB 2 slopes down from Mississippi River toward the northwest and north, toward DB 7. DB 2 receives little natural runoff from adjacent basins. DB 2 is drained by DPS 2.

DB 2 generally corresponds to neighborhoods constituting the CBD and Upper French Quarter areas of the City.

Drainage Basin 3 (approximately 2420 acres)

Topography of DB slopes down from the Mississippi River toward Lake Pontchartrain, but DB is transected by Esplanade Ridge and Gentilly Ridge. The ridges intersect on the Lake side of Broad Ave. DB 3 contributes runoff to: DB 2 (toward the southwest, but partially blocked by Orleans Ave); to DB 17/19 (toward the east); and DB 4 (toward the north). Adjacent DBs contribute little natural runoff to DB 3. DB 3 is drained by DPS 3.

DB 3 generally corresponds to neighborhoods constituting the Lower French Quarter, Faubourg Marigny, Fairgrounds, 6th Ward and 7th Ward areas of the City.

Drainage Basin 4 (approximately 4410 acres)

Topography of DB 4 slopes downward from south to north. North of Robert E Lee Blvd, the land elevation is higher. Bayou St. John has little natural levee elevation and Bayou St. John is not integrated into the municipal drainage system. DB 4 receives some natural runoff from DB 3 west of London Ave. DB 4 is drained by DPS 4.

DB 4 generally corresponds to neighborhoods constituting the Gentilly Rd to Lake Area of the City.

Drainage Basin 6 (approximately 2940 acres)

Topography of DB 6 slopes from Mississippi River toward the north, bounded by Carrollton Ridge on east and by the Upper Protection Levee on west. In addition, the principal canal draining DB 6, the 17th St Canal, receives drainage discharge from Hoey's Basin in Jefferson Parish. DB 6 otherwise receives only limited natural surface runoff from any adjacent DBs. DB 6 contributes runoff to DB 12 and DB 7 north of Metairie Ridge. DB 6 is drained by DPS 6.

DB 6 generally corresponds to neighborhoods constituting the Carrollton, Gert Town and Universities areas of the City.

Drainage Basin 7 (approximately 2930 acres)

Topography of DB 7 is divided by Metairie Ridge. South of Metairie Ridge, topography slopes toward south (Mid-City) with interruption by low Carrollton Ridge. North of Metairie Ridge, topography slopes downward toward north and the boundary with DB 12. Bayou St. John has little natural levee elevation, as noted above, Bayou St. John is not integrated into the municipal drainage system. DB 7 receives natural runoff from DB 6 North of Metairie Ridge and contributes runoff to DB 12. DB 7 is drained by DPS 7.

DB 7 generally corresponds to neighborhoods constituting the Mid-City area of the City.

Drainage Basin 12 (approximately 2410 acres)

Topography of DB 12 slopes downward from the south toward Robert E Lee Blvd. The topography is elevated north of Robert E Lee Blvd. DB 12 receives natural runoff from DB 6 (west of West End Blvd.) and DB 7. DB 12 is drained by DPS 12.

DB 12 generally corresponds to neighborhoods constituting the Lakeview area of the City.

Drainage Basin 17 and 19

Topography of DB 17 and DB 19 generally slopes downward from the Mississippi River toward the north. The elevated roadbed of the Norfolk Southern Railroad (Press St) divides DB 17 and 19 into western and eastern portions, while the Florida Avenue Canal divides the northern portion of the basin from the southern portion. The boundaries of DB 17/19 on the north, east and south are higher than on the west and the western portion of DB 17 and DB 19 receives natural runoff from DB 3. DPS 17 is basically a low-capacity lift station for DPS 19.

DB 17 and DB 19 generally corresponds to neighborhoods constituting the Bywater, Florida and Desire areas of the City.

The S&WB large drainage network consists of pipes (>36" diameter), box canals/closed canals and open canals. Total length of each of these features varies by documentary source. Some discrepancies are likely due to classification of features by varying standards for canal definitions.

- Pipes (>36-in diameter)
  - The Veolia Condition Assessment (2017-2018) does not provide a total asset type summary.
- *Box Canals/Closed Canals*. Statements of total city-wide box canal asset length vary from 90 miles (S&WB) to 59 miles (Veolia).
  - *Tributary Canals* convey water from the individual drainage basin pipe network to drainage pumping stations. Some of these closed canals may be very large, such as the Napoleon Avenue and Claiborne Avenue Canals, which drain DB 1.
  - *Transmission Canals* convey water from one drainage pumping station to another. They may be open or closed and may also receive water from the individual drainage basin pipe network. Major closed transmission canals within the Old City include the Orleans Avenue Canal (a portion between DPS 2 and DPS 7) and the Broad Avenue Canal.

*Open Canals*. Statements of total city-wide rectangular canal asset length vary from approximately 90 miles (S&WB) to 138 miles (Veolia)

- *Open transmission canals* convey water from one drainage pumping station to another and may also receive water from the individual drainage basin pipe network. Major open transmission canals within the Old City include the Melpomene/Washington/Palmetto Canal and the Florida Avenue Canal.
- *Outfall canals*. Outfall canals convey water discharged from outfall pumping stations to Lake Pontchartrain. These are:
  - The Metairie Outfall Canal [also referred to as 17<sup>th</sup> St. Canal] (DPS 6)
  - Orleans Avenue Canal (DPS 7)
  - London Avenue Canal (DPS 3 and DPS 4)

These outfall canals are typically near to the level of Lake Pontchartrain. The Permanent Pump Stations at the Lake and the Metairie Outfall Canal, Orleans Canal and London Canal, function to prevent storm surge from entering the outfall canals and do not function during rain events not accompanied by storm surge.

DPS 19 discharges into the Industrial Canal (Inner Harbor Navigation Canal) north of Florida Avenue. This outfall is also typically near to the level of Lake Pontchartrain. The Industrial Canal can be closed to storm surge by operation of the Seabrook Sector Gate.

The Veolia Condition Assessment (2017-2018) provided a summary by diminished capacity by asset type:

- Pipes (>36-in.): Summary of diminished capacity is not provided

- *Box Canals/Closed Canals*: Capacity reduced by 22 percent
- *Open canals*: Capacity reduced by 14 percent

The S&WB operates and maintains a relatively small capacity force main system (a pipeline that conveys water under pressure) for discharge of constant duty pumps from the Old City drainage pumping stations to an outfall at the Mississippi River. This force main does not play any significant role in storm water drainage.

**2.2. PUMPS**

The S&WB citywide operates and maintains 24 drainage pumping stations containing 124 pumps. Drainage pumping stations contain drainage pumps (large pumps for the removal of rainfall) and smaller constant duty pumps (principally for managing groundwater). Drainage pumping stations in the Old City and storm water discharge paths from the stations are shown in Figure 11. From this map it is apparent that some of the storm water is pumped two times before it reaches Lake Pontchartrain. Discharge from DPS 1 is pumped by DPS 6. Discharge from DPS 2 can be routed through DPS 3 or 7 but was routed through DPS 7 during the July and August flood events. Discharge from DPS 17 is routed to DPS 19.

The nine drainage pumping stations in the Old City as of July 2017 contained 58 pumps. Of these, 47 were drainage pumps with a combined nominal pumping capacity of 34,490 cubic feet per second (cfs) and 11 constant duty pumps with a combined nominal capacity of 694 cfs.



**Figure 11 Drainage Pumping Stations and Discharge Paths**

Table 1 summarizes the Old City drainage pumping stations assets.

**Table 1. Pump Assets of Old City Drainage Pumping Stations**

Location	Pump ID	Size	Freq (Hz)	Nom. Flow (CFS)	Station Nominal Total (CFS)
DPS1	A	12'	25	550	6,825
DPS1	B	12'	25	550	
DPS1	C	14'	25	1,000	
DPS1	D	14'	25	1,000	
DPS1	E	14'	25	1,000	
DPS1	F	11'	60	1,100	
DPS1	G	11'	60	1,100	
DPS1	1 VERT	6'	25	225	
DPS1	2 VERT	6'	25	225	
DPS1	CD 1	3'	25	60	
DPS1	CD 2	2'	25	15	
DPS2	A	12'	25	550	
DPS2	B	12'	25	550	
DPS2	C	11'	25	1,000	
DPS2	D	11'	25	1,000	
DPS2	CD 2	42"	25	25	
DPS2	CD 3	42"	25	25	
DPS3	A	12'	25	550	4,260
DPS3	B	12'	25	550	
DPS3	C	14'	25	1,000	
DPS3	D	14'	25	1,000	
DPS3	E	14'	25	1,000	
DPS3	CD 1	3'	25	80	
DPS3	CD 2	3'	25	80	

Location	Pump ID	Size	Freq (Hz)	Nom. Flow (CFS)	Station Nominal Total (CFS)
DPS4	1	8'	60	320	3,720
DPS4	2	8'	60	320	
DPS4	C	10.5'	25	1,000	
DPS4	D	10.5'	25	1,000	
DPS4	E	10.5'	25	1,000	
DPS4	CD	30"x63"	25	80	
DPS6	A	12'	25	550	9,580
DPS6	B	12'	25	550	
DPS6	C	14'	25	1,000	
DPS6	D	14'	25	1,000	
DPS6	E	14'	25	1,000	
DPS6	F	14'	25	1,100	
DPS6	G	10.5'	25	1,000	
DPS6	H	10.5'	60	1,100	
DPS6	I	10.5'	60	1,100	
DPS6	CD 1	30"x63"	25	90	
DPS6	CD 2	30"x63"	25	90	
DPS6	V1	-	60	250	
DPS6	V2	-	60	250	
DPS6	V3	-	60	250	
DPS6	V4	-	60	250	
DPS7	A		25	550	2,690
DPS7	C	14'	25	1,000	
DPS7	D	14'	60	1,000	
DPS7	CD 1	30"x63"	25	70	



Location	Pump ID	Size	Freq (Hz)	Nom. Flow (CFS)	Station Nominal Total (CFS)
DPS7	CD 2	30"x63"	25	70	
DPS12	D	10'	25	1,000	1,000
DPS17	A	30"x63"	25	150	300
DPS17	D	30"x63"	25	150	
DPS19	V1	6'	60	250	3,650
DPS19	V2	6'	60	250	
DPS19	H1	10'	60	1,050	
DPS19	H2	10'	60	1,050	
DPS19	H3	10'	60	1,050	
Total CFS:				35,184	

Table 2 contains the pumps which were not in service on July 22 and August 5 because they were down for repair.

**Table 2 Pumps Not in Service July 22 and August 5**

Location	Pump ID	Size	Freq (Hz)	Nom. Flow (CFS)
DPS1	V2	6'	25	225
DPS1	CD1	3'	25	60
DPS6	C	14'	25	1,000
DPS6	D	14'	25	1,000
DPS6	F	14'	25	1,000
DPS6	I	14'	60	1,000
DPS6	CD1	3'	25	90
DPS6	CD2	3'	25	90
DPS7	C	14'	25	1,000
Total CFS:				5.465

- Small pumping stations
  - Two small unmanned drainage pumping stations drain the Hollygrove neighborhood: The Pritchard St. pump station (253 cfs) and the Oleander pump station (99 cfs).
- Underpass pumps
  - Underpass pumps. The S&WB remotely operates unmanned pumps at 12 highway/rail road underpass locations in the City. These small pumps range in size from 5 cfs to 33 cfs.

A representative cross section of a pumping station is shown in Figure 12. When a pump is started, the screw turns in a dry housing and no water is moved. Once water levels in the suction basin rise to a predetermined (rule of thumb) level, vacuum pumps are used to draw water from the suction basin into the suction bell and to load the pump. This priming action allows the screw to move water through the discharge bell. In dry conditions, suction basin levels are kept low to prepare for a rain event. If the suction basin rises sufficiently, water levels rise in the drainage basin and create flooding. Discharge through the pump is limited by the capacity of the discharge canal.

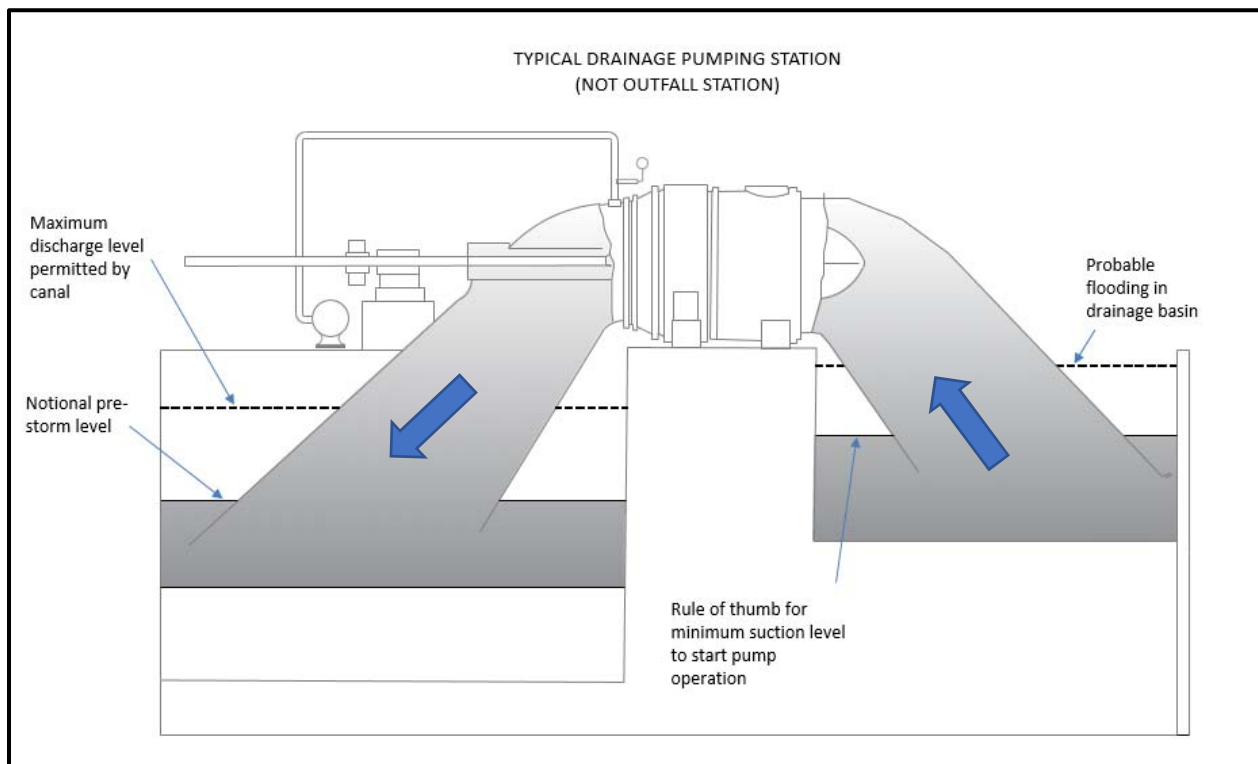

Figure 12 Typical Drainage Pumping Station

### **2.3. SYSTEM DESIGN STANDARD AND PUMPING CAPACITY**

*Historical Background.* For more than 100 years the Old City drainage system has grown from a unified original plan in interaction with changing patterns of residential and commercial development. The 1895 drainage plan on which the original pumping system was based was developed when precipitation runoff within the Old City boundaries was very much less than in the present, but pumping technology was also less advanced. The Wood horizontal screw pump (1915) allowed urban expansion in areas within the Old City boundaries that were naturally too wet to build on.

As a consequence of heavy precipitation, poor absorption of rainfall by the ground, topography and surrounding levees, almost all precipitation must be pumped out of the Old City. The drainage system utilizes a series of pumping stations to lift the drained water to run by gravity to ultimate pumping station discharge into outfall canals. Within the Old City, rain event drainage is discharged to outfall canals at the level of Lake Pontchartrain, rather than into the Mississippi River. Natural levee elevations along the Mississippi River, and the height of the river itself, would make gravity drainage between pumping stations and outfall into the river difficult without very much greater drainage capacity than the system has in the present day.

*System Design Standard.* System design standards in a contemporary engineering sense are unclear for the early decades of the New Orleans drainage system, other than lowering the water table and a timely removal of rain from City streets. Likely by the mid-20th century, the S&WB began to state that the system was engineered for a “1st hour performance” of storage of 0.5-in. of rain and pumpage of 0.5-in. of rain in the first hour of rainfall, with pumped drainage of 0.5-in. of water subsequent to the first hour. This standard is essentially a per hr. pumping rate of 0.5-in. of rainfall over the drainage area. We have termed this the target performance standard.

Variations of the target performance statement have frequently been used by public officials and others to describe the pumping design standard under which the S&WB drainage system has been planned, maintained and operated. However, as simple as the performance standards sounds, it can be misleading. The standard refers to a rate of drainage and pumping from collection within the S&WB system to outfall discharge. It makes no reference to the operation of the DPW street drainage system. Strictly speaking, it also does not correspond well to actual meteorological patterns of rainfall intensity, duration or frequency.

*Target performance vs. precipitation frequency estimate performance.* These two concepts are concerned with very different metrics. The target performance standard does not refer to a precipitation frequency estimate (PFE). By definition, a PFE is the depth of precipitation at a specific location for a specific duration that has a certain probability of occurring in any given year. The PFE is reflected in standards for engineering design for level of service (LOS) and is commonly used to describe rain events such as a “10-year storm,” “500-yr storm,” etc. The pattern of rainfall for these events can be modeled from historic data. These terms are sometimes misunderstood as only the likely frequency of precipitation of a given intensity. They also represent likelihood of a rainfall of a certain intensity in any year. For example, a “10-yr storm” refers to a rain event with a one in ten chance of occurring every year.

The target performance standard indicates a LOS which is inadequate to prevent flooding in a “1-yr storm” or a rainfall of 1-3 hours in duration with a 100% likelihood of occurring each year, as indicated in Table 3 below.

**Table 3. Precipitation Depth – Duration Frequency Estimates**

Duration	Average Recurrence Interval (rainfall shown in inches)								
	1-Mo*	3-Mo*	6-Mo*	1-Yr	5-Yr	10-Yr	25-Yr	50-Yr	100-Yr
1 hr.	.8	1.3	1.7	2.03	2.85	3.34	4.09	4.73	5.42
3 hr.	1.1	1.8	2.3	2.89	4.07	4.86	6.14	7.27	8.55
6 hr.	1.2	2.0	2.6	3.45	4.95	5.96	7.62	9.11	10.8
12 hr.	1.3	2.3	2.9	4.02	5.91	7.13	9.09	10.8	12.7
24 hr.	1.4	2.5	3.3	4.64	6.94	8.35	10.5	12.4	14.5

*\*Orleans Parish [CDM Smith 2010]; \*\* at DPS 2 [National Climatic Data Center]. Yellow indicates PFE total falling within the target performance standard; pink indicates PFE total greater than the target performance standard.*

From the above table it may be observed that the New Orleans drainage system performance standard is less able to handle rain events as the average recurrence interval grows longer; but this would likely be true of any drainage system.

Another conclusion might be that the drainage pumping system is capable of handling the 10-yr, 24-hr storm that is the basis for the LOS sought by the City of New Orleans Stormwater Management Capital Improvement Plan (CDM, 2010); however, this is an oversimplification. Within a 24-hr, 10-yr event the distribution of rainfall has a peak of intensity that exceeds the 0.5-in/hr that constitutes the target pumping performance rate for the S&WB drainage system. Whenever a) drainage system storage is full and b) rain falls faster than 0.5-in/hr, water will collect on the ground surface (i.e. flood) and this would certainly be the case in a 10-yr storm.

Thus, there would be flooding during a typical 10-yr, 24-hr event, despite the S&WB system supposedly being able to handle that amount of rain with its performance standard. More significant is the intensity and spatial distribution of rainfall within the duration of the event. The spatial distribution of rainfall intensity in a typical subtropical or tropical rain event may result in a significantly more or less intense event occurring within each drainage basin in the Old City. For example, one drainage basin may experience a 50-yr, 6-hr storm while the adjacent drainage basin experiences a 2-yr, 6-hr storm during the same parish-wide 10-yr, 6-hr event.

The pattern of rainfall intensity affects runoff and drainage performance and it is complex to analyze how a parish-wide or even Old-City-wide event would manifest itself in localized flooding.

Each drainage pumping station has a nominal pumping capacity, a design pumping capacity and a target pumping capacity. Nominal pumping capacity is the “nameplate” capacity of all of the pumps in a DPS. Many pumps in the system actually function below nominal capacity due to a variety of technical issues.

Design pumping capacity refers to the DPS maximum capacity intended by the current design of the basin transmission canals, the DPS suction basin, the pumps themselves and the DPS discharge basins,

receiving canals and outfall pumping stations. Most drainage basins (with significant exceptions) are designed with a redundancy of pumping capacity that is constrained in use. For example, this may be due to infrastructure considerations such as the inability of a discharge basin/transmission canal to receive the discharge of the station if all drainage pumps were operated at once. Typically, pumping redundancy is partially provided by a station having drainage pumps operating with 25 Hz power and drainage pumps operating with 60 Hz power, to provide flexibility in powering pumping operations according to power supply conditions.

Target pumping capacity is a calculation of the pumping capacity required to remove 0.5-in. of rainfall from the total drainage basin area, assuming 100 percent runoff. This has been calculated as drained area (acres) divided by 2 (BCG 2010).

Nominal pumping capacity, design pumping capacity and target pumping capacity for each drainage pumping station are indicated below in Table 4 :

**Table 4. Pumping Capacities Drainage Pumping Station in the Old City**

DPS	Basin area (acres) <sup>1</sup>	Additional basin area drained (acres)	Nominal pumping capacity (cfs)	Design pumping capacity (cfs)	Target pumping capacity (cfs) = drained area (acres)/2	Installed Capacity vs. Design Capacity
DPS 1	5,540		6,825	5,800 <sup>2</sup>	2,770	246%
DPS 2	1,610		3,150	2,600 <sup>3</sup>	805	391%
DPS 3	2,420	1000 <sup>4</sup>	4,260	4,260	1,710	249%
DPS 4	4,410		3,720	3,720	2,205	169%
DPS 6	2,940	8,040 <sup>5</sup>	9,580	9,580	5,490	175%
DPS 7	2,930	1,000 <sup>6</sup>	2,690	2,690	1,965	137%
DPS 12	2,410 <sup>7</sup>		1,000	1,000	1,205	83%
DPS 17+19	4,380		3,920	3,650	2,190	179%
	26,640	10,040	35,175	33,300	18,340	

*From CDM Smith GIS; differs from BCG calculation of area*

1. Design pumping capacity limited by capacity of Melpomene/Washington/Palmetto Canal
2. Design pumping capacity limited by capacity of Orleans Canal
3. Drainage (maximum) from DPS 2; BCG, Exhibit K05
4. Drainage from DPS 1 (5,440 acres) and Jefferson Parish (2,500 acres)
5. Drainage (maximum) from DPS 2; BCG, Exhibit K05
6. Acreage of basin is from CDM Smith GIS; differs from BCG calculation of area

From the table above, it can be seen that some stations have considerable pumping redundancy with which to meet the performance target (pumping 0.5-in./hr.) while other stations have less, with most stations falling between a design capacity/target capacity ratio of 1.5 to 2.0. Notable exceptions are DPS 2, with a design capacity/target capacity ratio of more than 3.0 and DPS 12, with a design capacity/target capacity ratio of less than 1.0. The latter may be the result of basin boundaries as drawn by CDM, which differ from boundaries identified by BCG, resulting in a larger DB 12 area.

Major drainage network projects completed in recent years resulted from design response to previous rain/flood events. Congress authorized the federal Southeast Louisiana (SELA) Drainage program in 1996, administered under a project cooperation agreement between S&WB and the U.S. Army Corps of Engineers. The purpose of the three-phase project is to reduce flood damages in the City of New Orleans and surrounding parishes by constructing new pumping stations, adding pumping capacity at existing stations and enlarging and improving drainage canals. While major features of the project had been completed as of summer 2017, the overall program remained incomplete.

Within the Old City of New Orleans, features of the SELA project included adding pump capacity at DPS 1, enlarging the Hollygrove Drainage Canal and Prichard Street pump station and enlarging the Jefferson Avenue, Napoleon Avenue, Louisiana Avenue, Claiborne Avenue and Florida Avenue canals. As of summer, 2017, the Louisiana Avenue and Florida Avenue canals projects remained under construction.

#### **2.4. POWER GENERATION**

The S&WB drainage system was developed historically to utilize 25 Hz electrical power for powering drainage, sewerage and water supply pumps. Due to concerns about reliability of power supply, the S&WB has operated its own power generation facilities and distribution feeders since the initial operation of the drainage system, rather than relying on commercial power supplies. During the course of the 20th century, 25 Hz power was largely supplanted by 60 Hz power as a national standard; however, issues related to converting 25 Hz-powered pumps to 60 Hz, including expense and difficulty of retrofitting existing pumping stations, contributed to continuation of 25 Hz usage by the S&WB. More detailed discussions of power generation and distribution are contained in Section 5 of this report.

25 Hz power generation The S&WB has four turbines to produce electric power, all located at the Carrollton Plant as shown in Table 5.

**Table 5. S&WB 25 Hz Power Generation Asset Status**

<b>Turbine</b>		<b>Frequency (Hz)</b>	<b>Power Rating, megawatts (MW)</b>	
Turbine G1	Steam generator	25	6	In service on July 22, August 5 and 8/08/17
Turbine G3	Steam generator	25	15	NIS July 22, August 5 and 8/08/17
Turbine G4	Steam generator	25	20	NIS July 22, August 5 and 8/08/17
Turbine G5	Gas turbine generator	25	20	In service on July 22, NIS August 5 and 8/08/17

Normal power requirement to operate sewerage, water supply and drainage constant duty pumps is approximately 4 MW. Power requirements during a major drainage event could be ten times that amount.

Frequency changers. The S&WB has five frequency changers, which convert S&WB-generated and Entergy-supplied 60 Hz electricity to 25 Hz, which can then be distributed to older pumps operating with 25 Hz power. It is possible to convert 25 Hz power to 60 Hz power with the frequency changers, but this is apparently not performed. The five frequency changers are:

Carrollton, FC 1 and FC 2

Station D (DPS 17 or Peoples Ave), FC 3 and FC 4

- Plant Frequency Changer (PFC), Carrollton Plant

60 Hz power generation. The S&WB has a single 60 Hz generator at the Carrollton Plant. As of the summer of 2017 and as seen in Table 6 below, four drainage pumping stations had generators large enough to power drainage pumps. These generators are intended for emergency use to supply power to pumps within the stations when Entergy supply is interrupted. They are not configured to send power to other stations.

**Table 6. S&WB 60 Hz Power Generation Assets During Loss Events**

Turbine	Frequency (Hz)	Power Rating megawatts (MW)
Turbine G6	60	15
DPS 6	60	3.75 MW
DPS 7	60	3 MW
DPS 19	60	2 x 2.5 MW

- *Station generators.* All drainage pumping stations within the Old City (with the exception of DPS 12) have small (80 kW to 400 kW) “house generators” capable of powering the lights and electrical instrumentation of the stations in case of failure of Entergy-supplied 60 Hz power. These are not large enough to power drainage pumps.
- *Consumption of Entergy 60 Hz power.* The S&WB pumping system is able to directly consume 60 Hz power supplied by Entergy at those stations with 60 Hz pumps configured to utilize outside power. As indicated above, a minority of large drainage pumps in the Old City use 60 Hz power and drainage pumping stations 3 and 17 have no 60 Hz pumps. Where 60 Hz and 25 Hz pumps are redundant, it has been usual during a rain event to operate one or more 60 Hz pumps from Entergy-supplied power first and then to request S&WB-generated power for pumps in the same station.

**2.5. POWER DISTRIBUTION**

Decisions as to distribution of power to the drainage pumping stations for pump operations are made by S&WB Central Control (CC).

- Drainage station operators request power to utilize pumps in response to weather and drainage conditions at their stations.
- When demand for electric power is anticipated, CC declares “Rain Load” to notify the boiler department that steam will be needed for additional steam turbine generation, or in the case of Turbines 5 or 6, that they will be needed. CC also directs operation of frequency changers to be brought online.
- CC notifies drainage station operators as to which feeders to utilize for pump operation. Limitations on available power or the configuration of the system may require CC to “refuse” a request to use a particular pump or to order operation of a pump or pumps other than those requested by the drainage station operator.



25 Hz Feeder system. The S&WB largely distributes its self-generated power to the drainage pumping stations via subterranean feeders, which are theoretically less prone to interruption than aerial feeders. However, many of these feeders are beyond their expected design life and there are numerous reliability issues. Feeder maintenance, replacement and operational impacts on July 22 and August 5 are discussed further below.

60 Hz power distribution system. The S&WB has underground 60 Hz feeders from its own generators. Entergy-supplied 60 Hz power distribution in the system is through aerial feeders. The unreliability of aerial feeders is an issue for S&WB operations, with wind and other factors causing momentary and longer losses of power (and consequent interruption of pump operation).

There are more than 90 separate underground and aerial 25 Hz and 60 Hz feeders in the S&WB distribution system. The system is complex, and CC remains non-automated, with operations relying heavily on CC staff experience and ability to respond quickly to dynamic conditions.

Although there are generally multiple routes to power most pumps in the Old City system, there are notable exceptions; e.g., D Pump D at DPS 12 is fed by a single “dead end” feeder that also feeds G Pump at DPS 6; consequently, lacking an alternative feeder to G Pump, both pumps cannot be run at the same time.

A power-constrained operating environment particularly as was the case on August 5, 2017, caused CC to make relatively unusual arrangements for power distribution among the Old City pumping stations.

### **3. DATA COLLECTION**

The analysis of the July and August rain events required an extensive amount of data gathering. With a system this complex, there were a multitude of outlets in which data was gathered. Information including internal records and documents from S&WB and DPW, external records and documents from subcontractors, interviews of key personnel and site visits to multiple production facilities. Compilation, organization and summarization of all of the data received are described below.

A running list was maintained based on the documents requested and received throughout the project. A total of 198 documents from both S&WB and DPW were requested and 45% or 89 out of the 198 documents were not received. Documents were not received because either they do not exist, or they were not provided. The documents received were either provided in electronic or paper form.

Multiple interviews were conducted with personnel who either currently are or were employed with S&WB, DPW and CH2M. Each person interviewed either directly participated in the event(s) or contains detailed knowledge of the interworking of S&WB and/or DPW systems. A list of the interviews completed is provided below:

#### Sewage & Water Board Interviews:

- Interim Executive Director
- General Superintendent
- Interim General Superintendent
- Drainage and Sewerage Supervisor
- Drainage Supervisor
- Power Supervisor
- High Lift Supervisor
- Utility Master Maintenance Supervisor
- Facility Maintenance Supervisor
- Emergency Response Supervisor
- Information Systems Manager
- Project Delivery Program Manager
- Project Controls Manager
- Executive Counsel & Director of Intergovernmental Affairs
- Deputy General Superintendent
- Central Control Supervisor
- Former Members of the Board of Directors

- Former General Superintendent
- Electrical Department Supervisor
- Engineering Department Manager
- CAASWORKS Specialist
- Utility Master Maintenance Spec II
- Utility Master Maintenance Supervisor
- Facility Maintenance Engineer
- Electrical Department Supervisor
- Drainage Pumping Station Operators

City of New Orleans Interviews:

- Director of Public Works
- Investigative Contractor for City of New Orleans
- Chief of Staff to the Chief Administrative Officer at the City of New Orleans
- Deputy Director of Homeland Security and Emergency Preparedness

DPW Director of Public WorksCH2M: Project Manager

A summary of the data reviewed by the investigation team is provided below:

- Log books for DPS and Central Control
- Rainfall data
- Damage/claims
- Hydrological Studies
- S&WB power generation
- Entergy power supplied
- Power distribution system
- S&WB internal system
- S&WB system performance
- DPW internal system
- DPW system performance
- Pump analysis

- Pump system performance
- S&WB equipment maintenance
- S&WB organizational charts
- DPW organizational charts
- S&WB budgets
- DPW budgets

#### 4. INCIDENT DESCRIPTIONS AND SYSTEM PERFORMANCE SUMMARIES

##### 4.1. JULY 22, 2017 LOSS EVENT

- A slow-moving heavy rainfall caused significant localized flooding in portions of the Old City basin on July 22. Initial rain reports in the metro region began about 1:00 PM. DPS 6 began operating drainage pumps at 1:03 PM and CC declared rain load at 1:15 PM. Intense rain began about 1:30 PM. 24-hr rainfall varied from 0.5-in DB 17 and DB 19 to 4.5 in DB 3 (a 10-yr to 25-yr storm). Flood-related calls to 911 began at 2:15 PM and ended at 3:45 PM. The New Orleans area was placed under a flood advisory until 4:00 PM. Rain duration was approximately 2-1/2 hours and ended at 4:09 PM.
- Many flooded streets were reported within the Old City, particularly in Mid-City. City Hall's NOLA Ready emergency preparedness service listed flooded intersections at Tulane and South Carrollton avenues (DB 7), Orleans Avenue and North Broad Street (DB 2), Paris Avenue and Burbank Drive (DB 4) and Esplanade and North Carrollton avenues (DB 7). The S&WB reported flooding at underpasses on Canal Boulevard (DB 7), St. Bernard Avenue (DB 4), Marconi Drive (DB 7) and Broad Street (DB 3).
- *911 Calls.* Only 17 non-underpass flood-related 911 calls were received by NOLA Ready on July 22, indicating few non-underpass emergency situations caused by flooding. Six of these calls originated in DB 3 and three calls each originated in DB 2 and DB 7. DB 1 and DB 19 each had two calls and DB 4 had one call. DB 6 and DB 12 had no flood-related 911 calls.
- *Pumping System Performance.* The S&WB pumping system in the Old City was laboring under some of the handicaps of the later August 5 event, with one important difference; two 25 Hz turbine generators were operational on July 22, giving Central Control greater flexibility in power allocation decisions.
  - DPS 1. All seven large drainage pumps and one of two smaller vertical drainage pumps were operational. At maximum, DPS 1 had four large drainage pumps and one vertical running to draw down the suction basin, which reached 15 ft at 4:00 PM. Despite a reactor fire soon after 4:00 PM which took C Pump out of action, DPS 1 had returned its suction basin to pre-rainfall level by about 4:30 PM, about three hours after significant rainfall began.
  - DPS 2 - All of its drainage pumps were operational. At maximum, DPS 2 had three large drainage pumps running to draw down the suction basin, which reached 14.2 ft at about 2:30 PM. DPS 2 returned its suction basin to pre-rainfall level by 5:00 PM.
  - DPS 3 - All drainage pumps were operational; however, at maximum, DPS 3 had three large drainage pumps running to draw down the suction basin, which reached 17.3 ft at about 3:00 PM. The station experienced a number of power problems: Frequency Changer #4 was lost shortly after 2:00 PM, tripping C Pump; and feeder 508 was lost about 3:30 PM, causing a pump to run backwards for an indefinite period. DPS 3 returned its suction basin to pre-rainfall level by 6:00 PM.

- DPS 4. - All of its drainage pumps were operational. At maximum, DPS 4 had three of five large drainage pumps running to draw down the suction basin, which reached 11.9 ft at about 3:00 PM. DPS 4 returned its suction basin to pre-rainfall level by about 6:30 PM.
- DPS 6.- 9 of the 13 drainage pumps were operational. At maximum, DPS 6 had 9 drainage pumps running to draw down the suction basin, which reached 14.3 ft at about 4:00 PM. DPS 6 returned its suction basin to pre-rainfall level by 5:30 PM.
- DPS 7 - 2 of 3 large drainage pumps were operational. The suction basin at DPS 7 rose 10 feet between 1:00 PM and 3:00 PM, indicating very heavy rain input into its drainage basin and significant input into the Orleans Canal from DPS 2. At maximum, DPS 7 had both drainage pumps running to draw down the suction basin, which reached 15.8 ft at about 3:00 PM. DPS 7 stopped pumping about 7:30 PM but its suction basin had not returned to pre-rainfall level by midnight.
- DPS 12. Logs and other data from DPS 12 were not available for July 22.
- DPS 17 and DB DPS 19 - Logs and other data from DPS 17 are not available for July 22. DPS 19 had three large and two smaller drainage pumps operational. At maximum, DPS 19 had 2 small and one large drainage pump running to draw down the suction basin, which reached 6.9 ft. at about 4:00 PM. DPS 19 ran small drainage pumps for brief intervals to return its suction basin to pre-rainfall level and last pumped at 10:30 PM.
- Central Control went off rain load at 9:20 PM.
- *Flood claims.* Only 12 NFIP claims were filed as a result of the July 22 event, making it by that measure a much less destructive event than August 5. Nine of these claims were in the 70119 zip code, which encompasses part of Mid-City, Tulane-Gravier, Treme-Lafitte and the upper 7th Ward. Claims were principally in Mid-City, although dispersed.

## 4.2. AUGUST 5, 2017 LOSS EVENT

### 4.2.1. RAINFALL

- Rainfall in the Old City was significantly more intense on August 5 than it was on July 22, in terms of both total rainfall and rainfall rates. As discussed below, the emergency response calls and post-event flood claims were much more numerous on August 5 than they were on July 22. Rainfall was not uniform in extent, intensity, or duration across drainage basins.
- *Timing-* Significant rainfall began within a fairly narrow time window in all Old City drainage basins. The rain gauge at DPS 7 recorded significant rainfall between 1:30 PM and 1:45 PM; at DPS 2 significant rainfall began by about 1:45 PM; at DPS 3 around 2:00 PM; and at DPS 17 about 2:30 PM. DPS 2 received intense rainfall until about 5:00 PM and DPS 3 received intense rainfall until about 5:30 PM.
  - *Pattern-* The precipitation moved generally from west to east. The area receiving intense rainfall was contained within the Old City and Algiers Point.

- *Rate and Intensity* - Rainfall at or exceeding a 5-yr, 6-hr event level (4.95 in.) was widespread across the Old City. The area receiving the most intense rainfall (8+ in. over 6 hours) was confined to DB 2, DB 3, DB 7, DB 17 and DB 19. A non-S&WB rain gauge in DB 3 recorded an Old City maximum total rainfall of 9.7 in. in 6 hours. Maximum peak rainfall rates (not rolling averages) also exceeded 8 inches per hour for brief intervals in DB 2, DB 7 and DB 17 and DB 19. Maximum peak rainfall rates exceeded 6-in./hr. in DB 1 and DB 4 for brief periods. Maximum hour rainfalls exceeded 0.5 in/hr. at all drainage pumping stations. DPS 2 and DPS 7 both recorded hour rainfalls of over 3-in./hr.
- Damage, Claims, 911 Calls.
  - 911 calls- 140 non-underpass flood related calls, as seen in Table 7 below, were received on August 5, indicating a significant number of emergency situations caused by flooding not in underpass locations. These August 5 calls were predominantly from DB 2, DB 3, DB 7, DB 17 and DB 19. Distribution of 911 calls is provided in Figure 13.

**Table 7. Flood Related 911 Calls**

Date	DB 1	DB 2	DB 3	DB 4	DB 6	DB 7	DB 12	DB 17+19
August 5, 2017	0	21	54	1	5	30	8	21

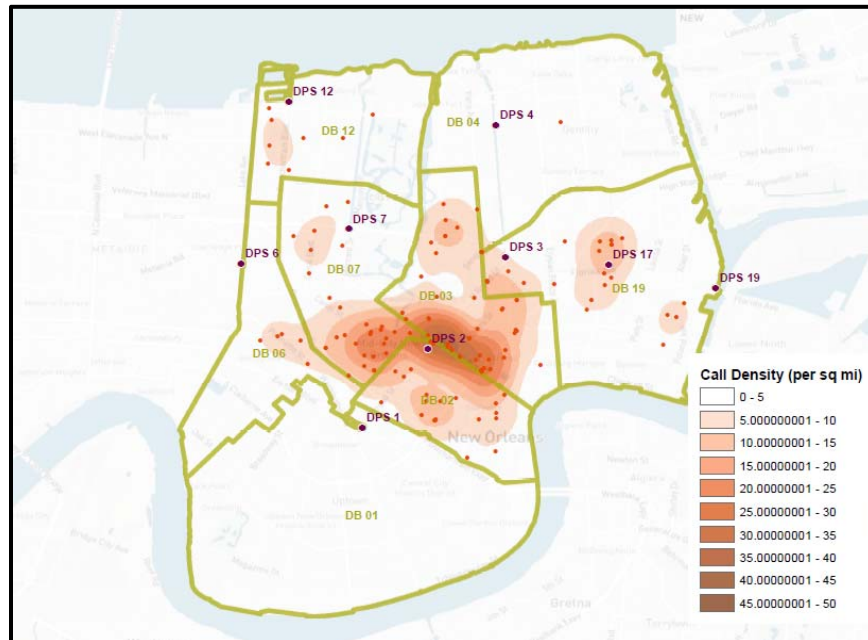

**Figure 13 911 Call Density Distribution**

A large number of flood damage claims for real property filed after the August 5 event. In addition to NFIP claims, NOHSEP compiled flood damage reports.

*NFIP claims.* 681 flood insurance claims were filed after the August 5 event. Nearly one-third of these claims were for properties located in DB 7; 24% were in DB 3; 20% were in DB 2; and 16% were in DB 17 and DB 19. Of these claims, there were 181 non-zero paid claims, totaling \$4.3 million. About 37% of the value of paid claims were for properties in DB 7. DB 3 and DB 19 each had about 25% of the value of paid claims. Distribution of NFIP claims is shown in Appendix D.2

City of New Orleans flood damage reports. NOHSEP compiled 1,334 residential property and automobile flood damage reports and 248 commercial property flood damage reports for the August 5 event. Report data has been compiled and is presented in Appendix D.4 and D.55. Residential flood damage reports were widely distributed, with major damage reports concentrated in DB 2, DB 3, DB 7, DB 17 and DB 19, with scattered major damage reports in DB 12, DB 17 and DB 19. Neighborhoods reporting concentrated major flood damages were:

- Tulane-Gravier (DB 2)
- Southern Mid-City (DB 2)
- Treme-Lafitte (DB 3)
- 7th Ward (DB 3)
- St. Roch (DB 3)

Scattered major residential flooding occurred in the following neighborhoods:

- St. Bernard/Fairgrounds (DB 3)
- Lakeview (DB 12)
- St. Roch/Florida/Desire (DB 17 and DB 19)

Commercial flood damage reports were less widely distributed although major damage reports generally correlated with areas of concentrated residential damage reports. Major commercial damage reports originated at:

- Canal St./CBD (DB 2)
- N. Broad St. (DB 2/DB 3)
- Tulane Ave. (DB 2/DB 7)
- Banks St. (DB 7)
- Harrison Av. (DB 12/DB7)
- St. Bernard Ave. (DB 3)

The City of New Orleans flood damage reports also contain limited flood depth data [Appendix D.3]. These flood depths are self-reported by the property owners and are uncorroborated. In addition, the exact datum from which individual flood level/depth is measured is unknown; it may be assumed to be “from the street” or “from the floor.”

A small number (fewer than 20) damage reports stated water was 36 inches in depth or greater. A much larger number of reports states water depth was greater than 12 inches. The spatial pattern of these 12+ inch reports shows concentrations in proximity to Orleans Ave. (DB 2/DB 3), in 7th Ward/St. Roch (DB3/DB 17 and DB 19) and to a lesser extent in southern Mid-City (DB 7/DB 2).

#### **4.2.2. COMMUNICATIONS**

Residents had little advance warning of flooding on August 5th. The National Weather Service had predicted a rainfall of 1-2 inches earlier that day. 911 calls of flooding in cars began at 3:15 PM in the St.



Bernard and Mid-City neighborhoods. By 3:30 PM 911 calls of structure flooding were reported in the Mid-City and the St. Bernard neighborhoods. No advisories were issued until 3:45 PM when the NWS issued a flood advisory which indicated street flooding may occur. By this time, vehicle traffic had proceeded into flooded streets. At 4:02 PM the NWS issued a flood warning which indicated structure flooding may be life threatening.

Delays in approval for communication resulted in the city failing to issue any advisories through NOLA until 4:06 PM when they issued a flash flood warning. This was 50 minutes after 911 calls first indicated a problem.

Press releases on flooding went out at 5:34 PM on August 5th and at 9:36 AM on August 6th. The City Office of Communications and NOHSEP made city and S&WB officials available to the media at 8:00 PM August 5th and 10:45 AM August 6th. S&WB officials indicated all pumping systems were operational and working at capacity. No indications of problems with drainage systems were relayed even though the public and media were aware of significant flooding occurring.

#### **4.3. DPW SYSTEM PERFORMANCE**

*Catch basin/small pipe performance* - Quantitative and comprehensive data concerning catch basin and small pipe performance on August 5 are not available. Anecdotal reports of catch basins appearing not to drain properly before, during and after the August 5 event are certainly available and widespread. More likely than not, diminished performance capacity of the DPW drainage system had an impact on localized flooding levels and duration during the event.

*Catch basin condition* - DPW data concerning catch basin condition is presented as (Appendix G.2, indicating whether a catch basin was assessed as clean or dirty and when it was cleaned. The data is a product of both the DPW catch basin maintenance assessment program and resident-reported drainage problems, so it is not a fully systematic or comprehensive database of catch basin and pipe condition everywhere in the system.

In addition, DPW GIS (CDM, 2010) indicates pipe size within the drainage system. This data is useful for mapping "hot spot" areas of undersized drainage pipes (<15" diam) (Appendix G Figure 2) Pipe Hot Spots. Unsurprisingly, there is generally a correlation between the historic era when an area of the City developed and the density of undersized pipe in that area. Most notably, older neighborhoods in DB 2 and portions of DB 3 and DB 7 that have relatively high proportions of undersized drainage pipes also received intense rain on August 5. More likely than not, pipe capacity issues in those areas contributed to the depth and duration of flooding and it is possible that impacts of undersized pipes could be greater than impacts of diminished pipe capacity due to clogging. Quantitative data is lacking and areas such as DB 12 and DB 19, also experienced flooding but have a lower density of undersized pipes. DB 2, besides having a relatively high proportion of undersized drainage pipe, also has the lowest percentage of pervious ground surface of any drainage basin, which increases quantity and speed of runoff. With caveats, the available DPW data does indicate areas where the condition of the catch basins and small pipes could have had an impact on flooding levels and duration during the event

#### **4.4. S&WB PUMPING SYSTEM CAPACITY**

The S&WB drainage system in the “Old City” of Orleans Parish is composed of eight drainage basins. Water in each basin flows through drainage structures to a drainage pumping station where it is pumped to outfall canals. In some stations, water is discharged to canals which transport the water to another pumping station. This requires water drained from some areas to be pumped twice, once at a lift or transmission station and once at the outfall station.

There are nine drainage pumping stations which house 100 large drainage pumps and 21 constant duty pumps. Constant duty pumps have relatively small pumping capacity and are intended for removal of water from day to day activities. Drainage pumps, with capacities of 550 to 1,100 cubic feet per second (CFS), provide water discharge for rainfall. The number of drainage pumps in a drainage station ranges from 1 to 13 depending on the required total flow capacity for a given pumping station. The pumps and associated suction basins and discharge structures are designed to allow a mix of pumps to be used at any given time to tailor the pumping volume to demand and to provide pumping capacity redundancy.

##### **4.4.1. PUMPING SYSTEM DESIGN CAPACITY**

A fundamental characteristic of the pumping system is the design water flow capacity. The drainage system was constructed based on recommendations in a report in 1895 at a time when hydrology was less developed and storm frequency as well as design rainfall was not well understood. A quantitative pumping rate standard was not mentioned in the 1895 drainage plan report but was developed later using simplified hydrologic methods. Historic understanding of the system capacity was removal of 1 inch of rainfall per hours for the first hour and one-half inch per hour removed by pumping for each hour thereafter. Rainfall in the first half hour was assumed to be absorbed by storage areas within the system including empty pipes, canals and dry roadways and one-half inch of rain was to be pumped to outfall. The S&WB had held this design basis as the standard of performance even though it is well below the 10-year design basis storm selected by the city.

BCG conducted a study of the 1 inch/one-half inch design capacity and found that demand in CFS was equivalent to one-half the area of the drainage basin in acres. This approach conservatively assumed 100% of the rainfall was carried into the drainage pumping station. Additionally, the three outfall stations (DPS 3, DPS 6 and DPS 7) re-pump water from transmission pumping stations, adding the runoff of those basins to the total water the outfall stations must pump. Lastly, DPS 6 also pumps water drained from 2,500 acres in Jefferson Parish. Thus, the total area requiring pumping is greater than the acreage of the Old City (Orleans Parish) alone. Depending upon calculations of area in each drainage basin, the flow capacity of installed pumping equipment in each pumping station in Orleans Parish generally (with exception) exceeds this design rainfall as discussed in

Table 8. The total installed pumping capacity of the Old City pumping stations is approximately 190% of the ½ in/hr. design capacity which we refer to in this analysis as “Target Capacity”, that is the performance standard which S&WB communicated to the public.

For DPS 1 and DPS 2, the capacity of the drainage pumping station is limited by the discharge canal capacity. Any excess capacity in each drainage station allows for redundancy should equipment be out of service for repair or replacement. It could also provide additional capacity beyond the ½ inch per hour design basis if allowed by configuration of the station’s discharge basin or canals.

**Table 8. Target and Installed Pumping Capacity for Drainage Pumping Stations**

DPS	Basin area (acres) <sup>1</sup>	Additional basin area drained (acres)	Nominal pumping capacity (cfs)	Design pumping capacity (cfs)	Target pumping capacity (cfs) = drained area (acres)/2	Installed Capacity vs. Target Capacity
DPS 1	5,540		6,825	5,800 <sup>2</sup>	2,770	246%
DPS 2	1,610		3,150	2,600 <sup>3</sup>	805	391%
DPS 3	2,420	1000 <sup>4</sup>	4,260	4,260	1,710	249%
DPS 4	4,410		3,720	3,720	2,205	169%
DPS 6	2,940	8,040 <sup>5</sup>	9,580	9,580	5,490	175%
DPS 7	2,930	1,000 <sup>6</sup>	2,690	2,690	1,965	137%
DPS 12	2,410 <sup>7</sup>		1,000	1,000	1,205	83%
DPS 17+19	4,380		3,920	3,650	2,190	179%
	26,640	10,040	35,175	33,300	18,340	

1. From CDM Smith GIS; differs from BCG calculation of area  
 2. Design pumping capacity limited by capacity of Melpomene/Washington/Palmetto Canal  
 3. Design pumping capacity limited by capacity of Orleans Canal  
 4. Drainage (maximum) from DPS 2; BCG, Exhibit K05  
 5. Drainage from DPS 1 (5,440 acres) and Jefferson Parish (2,500 acres)  
 6. Drainage (maximum) from DPS 2; BCG, Exhibit K05  
 7. Acreage of basin is from CDM Smith GIS; differs from BCG calculation of area

**4.4.2. DIMINISHED CAPACITY**

Multiple pumps were out of service on July 22, August 5 and August 8. In DPS 1, there was a 2% reduction in drainage capacity for pumps under repair. At DPS 6, the largest pumping station, 4 drainage pumps and 2 constant duty pumps were out of service which resulted in a 46% reduction in capacity. DPS 7 had a 37% reduction in capacity and a 2% reduction in at DPS 1.

DPS 6 and 7 used 100% of the pumps available to operate so if additional pumps had been operating (and sufficient power was available), more pumping capacity could have been provided by these stations potentially resulting in lower flood water levels and less time to clear flooding in drainage basins served by these stations. Flooding on August 5 was relatively limited in the drainage basin primarily served by DPS 1. A comparison of the operational capacity on July 22, August 5 and August 8 with design capacity is shown in Table 9. The table shows that the operational S&WB pumping capacity was near the 0.50-in/hr. target for these flood events except for DPS 7 and 12. The operational capacity of DPS 6 and 7 was well below the installed capacity.

**Table 9. DPS Operational Capacity vs. Target Capacity**

<b>DPS</b>	<b>Jul 22, Aug 5-8 Operational Capacity (CFS)</b>	<b>Operational Capacity vs Target Capacity (%)</b>	<b>Operational Capacity vs Installed Capacity (%)</b>
1	6,689	241%	98%
2	3,150	391%	100%
3	4,260	249%	100%
4	3,720	169%	100%
6	5,200	95%	54%
7	1,690	86%	63%
12	1,000	83%	100%
17/19	3,920	179%	100%
Totals	29,629	162%	84%

The operational capacity shown above is based on whether the pumps were available for service and do not include the effects of power limitations. As will be discussed in following sections, there was insufficient 25 Hz power available to operate all available pumps. As a result, multiple requests to start pumps were denied by Central Control due to power shortages. When the impact of the power shortages is included, the available maximum flow capacity drops.

Table 10 shows the maximum pumping capacity for the pumps that were actually used simultaneously at each station. The table also shows how this actual maximum flow capacity compares with the installed capacity and the design capacity for the station. Two stations, DPS 7 and 12, used 100% of the operating capacity at some point during the flood event on August 5. Four stations (DPS 1, 2, 3, 12) were able to achieve the design flow capacity at some point during the August 5 flood. All other stations did not meet the design capacity at any point. In some cases, this maximum flow capacity was achieved for only short periods or were significantly delayed so the diminished capacity effect is greater than shown in the table; however, some drainage basins experienced less intense rainfall and drainage demand was not consistent across the Old City.

**Table 10. Maximum Pumping Capacity Used**

DPS	Maximum Capacity Used (CFS)	Max Used vs Installed Capacity (%)	Max Used vs Operational Capacity (%)	Max Used vs Target Capacity (%)
1	3,425	50%	51%	124%
2	2,250	71%	71%	280%
3	3,000	70%	70%	175%
4	2,000	54%	54%	91%
6	4,650	49%	89%	85%
7	1,620	60%	96%	82%
12	1,000	100%	100%	83%
17/19	1,720	44%	44%	79%
Totals	19,665	56%	66%	107%

The Veolia condition assessment reviewed and tested mechanical and electrical performance of pumping system components including pumps, vacuum breakers, front gates and brakes. Significant deficiencies were found in every pumping station. This condition assessment report indicates major equipment issues which are reflected in the log books at each pumping station. These equipment issues are exacerbated by electrical power feeders which routinely fail. Pumps lost load multiple times at five of the eight pumping stations on August 5 and August 6. Pumps experienced mechanical failures at three stations and with some pumps spinning backwards in reverse flow at two stations. Even momentary failures can result in shut down of pumps, and in some cases caused the pump to spin backwards and reverse flow. Many of the mechanical issues in the stations are with systems designed to minimize the impact of power feed drops and prevent reverse flow and because these systems are in disrepair, reverse flow cannot be stopped quickly. The equipment issues identified in the Veolia assessment reflect a high potential for future pumping failures.

**4.5. DRAINAGE PUMPING STATION PERFORMANCE**

The performance of the S&WB drainage pumping system was analyzed using available data from drainage pumping station logs. Suction basin levels of the transmission or lift stations (DPS 1 and DPS 2) are proxies for the water levels within the overall drainage basins since they represent the water drained by gravity into the drainage network of the basin. The suction basins levels of outfall stations (DPS 3, DPS 4, DPS 6, DPS 7, DPS 12 and DPS 19) represent not only water draining to the stations by gravity from their own basins but also (at DPS 3, DPS 6, DPS 7, DPS 17 and DB 19) water flowing from the discharge basins of the transmission stations into the canals feeding the outfall stations.

A suction basin elevation of 16 ft is used by S&WB Drainage Operations staff as an approximate indicator of likely flooding in DB 1, DB 2, DB 3, DB 4, DB 6, DB7 and DB 12. On August 5, DPS 2, DPS 3, DPS 6, DPS 7 and DPS17 experienced suction basins rising to over 16 ft (Cairo Datum).

Pump run times and suction basin level response provide the metrics for analyzing pumping system performance during rainfall events. Graphical depictions of this data for DPS 3 is shown in Figure 14. Data for all pumping stations are presented in detail in Appendix F.

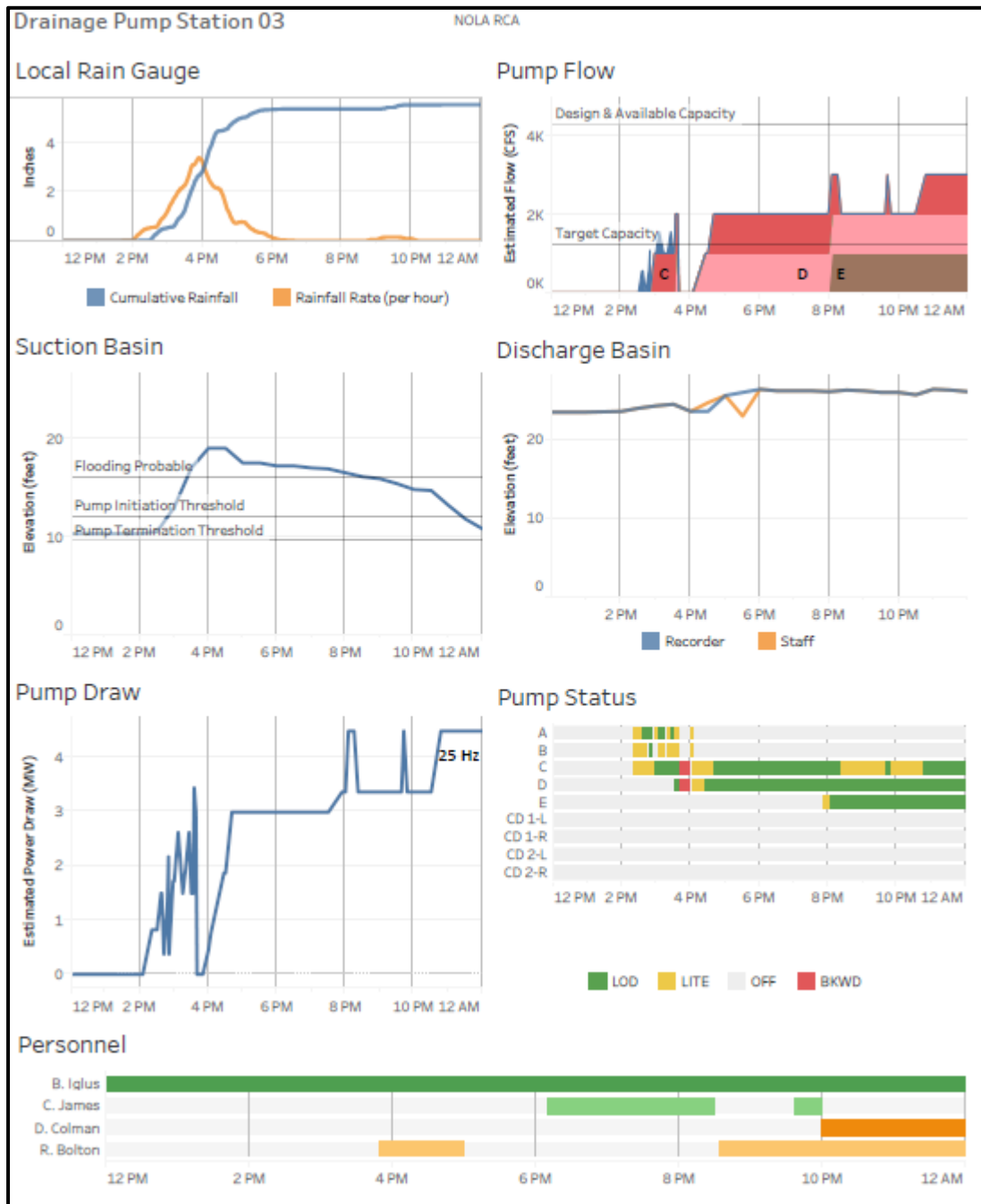

Figure 14 Drainage Pumping Station 3 Performance Timeline

DPS 1 commenced operation of drainage pumps around 3:00 PM when its suction basin level was close to 10 ft, above the 9-ft operations “rule of thumb” threshold to turn on pumps at this station. Three of the station’s large drainage pumps were utilized and the station reached its pumping “target capacity” prior to 4:30 PM. The suction basin reached a maximum level of 13.0 ft at 5:00 PM while the Metairie discharge (to DPS 6) reading was at a near-maximum of 20.1 ft. DPS 1 pumped its suction basin down to a plateau at about 10.5 ft by 9:00 PM.

DPS 2 suction basin water level increased rapidly over the period from about 2:00 PM to 4:00 PM, from a suction basin elevation of approximately 9.7 ft at 2:00 PM, to a maximum of approximately 16.9 ft at 4:00 PM. The DPS 2 log shows B and C Pumps started sequentially between 2:30 PM and 3:00 PM. The suction basin elevation at the time pumping commenced was close to the “rule of thumb” level to start pumps which is 11 ft. Three of the station’s large drainage pumps were utilized and the station reached its pumping “target capacity” prior to 3:00 PM while the suction basin level fell after 5:00 PM. DPS 2 pumped its suction basin down to a plateau at about 10.5 ft by 9:00 PM; however, basin water levels (in both St. Louis Canal and Broad St. box culvert) remained elevated (6 ft and 5 ft above pre-event levels in the respective canals) at 12:00 AM.

DPS 3 had all of its major drainage pumps available on August 5 but experienced several operational problems. The electronic suction level recorder at DPS 3 is unreliable and levels stated herein are those recorded manually by station operators from a staff gauge. From a suction basin water level of about 10.5 ft at about 2:00 PM, the DPS 3 suction basin level reached a maximum of approximately 19.0 ft at about 4:00 PM. The station operator loaded Pump A at 2:58 PM and at 3:00 PM the suction level reading was at 13 ft, 1 ft higher than the rule of thumb level to switch pumps on at this station (12 ft). DPS 3 experienced its highest manually-recorded suction basin level of 19.0 ft at 4:00 PM and at that time no pumps were running at DPS 3. Analysis identified six losses of power (feeder trips) affecting pumps A and B between 2:00 PM and 4:44 PM (leading to pumps running in reverse for an indefinite period and decision not to attempt further use of those pumps) and one loss of power (interruption of FC) affecting pumps C and D between 2:00 PM and 4:00 PM. By 5:00 PM DPS 3 had pumps C and D loaded and suction basin water level fell to a level of approximately 17.2 ft prior to 6:00 PM, falling to 10.8 ft by 12:00 AM. The suction basin at DPS 3 fell to near pre-event level by midnight on August 5; however, large drainage D and E pumps continued to run after midnight, E pump until about 1:30 AM on August 6 and D pump until 5:30 AM on August 6.

DPS 4 appears to have electronic suction level reader issues. The DPS 4 suction basin water level began to rise significantly after 4:00 PM from a level of about 8 ft at 16:00. The suction basin water level reached approximately 14.8 ft at about 5:30 PM. Rule of thumb level to switch pumps on is 10.5 ft. Operator request to load D Pump was refused at about 4:20 PM when suction level reading was likely around 14 ft. The operator loaded Pump D at about 4:50 PM, when level reading was about 14.6 ft. DPS 4 achieved its target pumping capacity for only a brief period after 6:00 PM. Operation of pumps appears to have lowered the suction basin level to approximately 9.5 ft by 12:00 AM.

DPS 6 on August 5 had four of its nine large drainage pumps not in service. The DPS 6 suction basin water level was rising from the start of rain and began to rise more rapidly after about 4:00 PM. The suction basin water level reached approximately 13 ft at about 5:10 PM from a level of approximately 8.8 ft at 3:30 PM. The suction basin water elevation at DPS 6 began to rise rapidly at a later point in time than at DPS 1, which discharges into the Washington Canal/Palmetto Canal, feeding DPS 6. Rule of

thumb level to switch pumps on is 10 ft. The operator started Pump E and Pump H around 3:30 PM with a suction level at about 10.5 ft. The operation of pumps lowered the suction basin level to approximately 12 ft by about 5:45 PM but the suction basin level again rose, reaching a maximum level of approximately 17 ft at about 7:10 PM, after which the suction basin level declined with large drainage B, E, G and H pumps operating.

Due to feeder limitations, operation of G pump at DPS 6 prevented use of D Pump at DPS 12 until G was unloaded at about 8:45 PM. According to interviews, Operations staff made a conscious decision to power G Pump at DPS 6 rather than D Pump at DPS 12 because of insufficient available power for both pumps and the contention that DB 12 received some drainage benefit from pumping in DPS 6 and DPS 7.

On August 5, DPS 7 had only two large drainage pumps available. The motor on C Pump (1000 cfs) failed and the pump went out of service on March 11, 2016 and was not repaired until after August 5. The electronic suction basin gauge at DPS 7 is also unreliable. DPS 7 began to experience rapidly rising suction basin water level from about 3:15 PM. At DPS 7, only D Pump and CD 1 Pump were loaded between 3:12 PM and 7:15 PM, at which time the operator loaded A Pump. The most rapid rate of suction basin water level at DPS 7 occurred between about 4:15 PM (level at approximately 10 ft) and 5:00 PM (level at approximately 16.5 ft.), an extraordinarily rapid rate of rise. Between 5:00 PM and 7:00 PM, with D Pump running, suction basin water level dropped gradually to about 16.2 ft. A Pump was loaded at 7:15 PM but suction basin elevation remained over 16 ft until after 8:30 PM. The suction basin remained elevated more than 4 ft above pre-event level at 12:00 AM.

DPS 2 discharges into the St. Louis Canal feeding DPS 7. A connection to DPS 3 through the Broad St. box culvert is available but not used. The DPS 7 suction basin reflected precipitation in its catchment area plus discharge from DPS 2. Suction basin water level began to rise at DPS 7 about 45 minutes to one hour after that at DPS 2, but the most rapid rise to maximum level at DPS 7 occurred very approximately 15 minutes to one-half hour after suction basin water level at DPS 2 rose rapidly. This may indicate similarly intense rain falling in both DB 2 and DB 7 nearly simultaneously from around 2:15 PM - 4:00 PM.

At DPS 12, a single large drainage pump was operational on August 5; however, the station is unmanned, and an operator is dispatched after an automatic alarm signals water level in the suction basin. Rule of thumb water level to switch pumps on for DPS 12 is 11 ft. On August 5, the electronic suction basin water level recorder at DPS 12 began to rise from a level of approximately 10.8 ft at about 3:00 PM, paused after about 3:30 PM, then continued to rise. An operator arrived at DPS at 7:50 PM, at which time suction basin level shown on a staff gauge was nearly 16 ft. As indicated by the DPS 12 station logs, a request to start and load D Pump was refused by CC at about 8:00 PM. The single drainage pump in DPS 12 was not loaded until after 8:45 PM, at which time the suction basin remained over 16 ft. In the interval between maximum suction basin level at DPS 12 and initiation of pumping at about 8:45 PM, suction basin level declined slightly. At 12:00 AM, the DPS 12 suction basin level remained over 14 ft.

Operation of G Pump at DPS 6 prevented use of D Pump at DPS 12 until G was unloaded at about 8:45 PM, due to feeder limitations. According to interviews, Operations staff made a conscious decision to power G Pump at DPS 6 rather than D Pump at DPS because of an absence of alternative power or pump



at DPS 6 and the contention that DB 12 received some drainage benefit from pumping in DPS 6 and DPS 7.

At DPS 17 + DPS 19, all pumps were available at both of these stations on August 5. The electronic suction basin level gauge and other ABB system features at DPS 19 were evidently malfunctioning. The DPS 17 and DPS 19 logs indicate that the suction basin level was at approximately 3.5 ft at 3:00 PM and rose after that to a maximum level of 7.3 ft (gauge datum is unknown) at 4:00 PM, before falling and rising again to 7.0 ft at 8:00 PM. All pumps at both stations were utilized at various times between 3:00 PM and 12:00 AM with the three large drainage pumps at DPS 19 loaded between 4:00 PM and 4:10 PM and two ran until 7:30 PM. Only one large drainage pump was loaded from 5:45 PM. The DPS 19 log indicates suction elevation had fallen to pre-1:00 PM level by 11:00 PM and pumping ceased at 11:10 PM.

#### **4.6. POWER GENERATION SYSTEM PERFORMANCE**

The vast majority of large capacity drainage pumps in the Old City S&WB system require 25 Hz electrical power supply. S&WB power operations has four turbine generators with 61 MW of 25 Hz capacity. S&WB also has frequency changers to convert 60 Hz power from Entergy to 25 Hz. Frequency changers #1 and #2 at the Carrollton plant have a combined capacity of 8.5 MW. At Station D, frequency changers #3 and #4 have a combined capacity of 12 MW. This yields a total of 81.5 MW. The total connected load for all installed pumps is 52 MW.

Turbine generator 4 was taken down in January 2012 for rebuild. This reduced the power generation capacity by 20 MW. Turbine generator 3 (15 MW) went down in March 2017. An emergency task order was issued by S&WB management to expedite repairs. Neither generator was available for the July and August flood events. On July 24, 2017, turbine generator 5 failed reducing the power generation capacity by 20 MW. This left the S&WB with a single 25 Hz turbine generator, G1, with a capacity of 6 MW.

With frequency changers added to the mix, there was a total power generation capacity of 29.5 MW. However, frequency changer #2 cannot be operated simultaneously with frequency changer #1 due to a shortage of available electrical feeders, thus the maximum potential power generation was 27 MW. The maximum 25 Hz power produced over the August 5 flood event was 13.3 MW. This is considerably below the connected load of 52 MW and also short of the maximum anticipated storm load of 40 MW. For comparison, on August 29, 2012 during hurricane Isaac, when turbine generators 1, 3 and 5 were operational, the total generated output was 30 MW.<sup>6</sup>

The S&WB power generation system was operating under severe constraints on August 5, compelling Central Control to devise relatively unusual routes to supply power to pumping stations requesting 25 Hz power for pump operation.

*Turbines.* Of the four 25 Hz turbines in the S&WB power generation system, only turbine generator 1 was in operation on August 5, with a nameplate output of 6 MW of 25 Hz power. Since startup demand of a single large drainage pump may be 3 MW, self-generated 25 Hz power was extremely constrained. G 1, which powered sewerage and water supply pumping as well as drainage operations pumping, was

---

<sup>6</sup> January 4, 2018 presentation to S&WB

in operation round-the-clock without failure on August 5. G 6, which produces 60 Hz power, was activated after 11:00 PM.

*Frequency changers* - The Station D FC #3 and #4 were started at about 2:00 PM. Plant FC was started after 4:00 PM. During operations, Station D frequency changers #3 and #4 tripped offline, causing pump failures at stations 1, 2, 3, 4 and 6. Where these pumps were under load, they began to run backward.

*Refusals* - Maximum effective power produced on August 5 was about 13.2 MW considerably less than the 52 MW required to power the system at full capacity. Drainage pump stations 4, 6 and 7 experienced Central Control refusal of operator’s requests for power, delaying use of pump assets.

*Station generators* - The station generators capable of powering drainage pumps at some drainage pump stations on August 5 were intended for extended emergency use and are utilized when Entergy power is interrupted. These were not utilized on August 5.

Pump Start Refusals

There were 15 requests for pump starts recorded in the log books at six stations on August 5, which Central Control refused due to unavailability of power. These are shown in Table 11. In nine of these cases, the total power consumed at the time was considerably less than the total available power. Reasons for these refusals were not provided. The most likely explanation is lack of an available feeder path for the available sources when sufficient overall power was available. Not all sources of power (G1 and frequency changers) can be routed to all available pumps simultaneously. This can be due to limitation in the feeder system design or in many cases is due to unreliable feeders which fail periodically. Decision-making regarding approval or refusal of pump start requests are made by Central Control based on their observation and understanding of the power generation, power consumption and feeder paths. Four additional pumps start denials occurred on August 6.

**Table 11 Pump Start Refusals**

Time	Date	Station	Requested Pump Start	Pump Flow Capacity (cfs)
3:11 PM	8/5/2017	2	A	550
3:22 PM	8/5/2017	3	A or B	550
4:44 PM	8/5/2017	3	A, B, or E	550/1000
7:08 PM	8/5/2017	3	E	1000
4:20 PM	8/5/2017	4	D	1000
4:20 PM	8/5/2017	4	E	1000
4:25 PM	8/5/2017	4	Any Big Pump	1000
4:30 PM	8/5/2017	4	B	1000
5:13 PM	8/5/2017	6	A or B	550
3:02 PM	8/5/2017	7	A	550
3:16 PM	8/5/2017	7	A	550
3:21 PM	8/5/2017	7	A	550
7:55 PM	8/5/2017	12	D	1000

A systematic evaluation of drainage conditions and needs throughout the basin, or coordination of station operations to regulate water levels within the system, is not an initial consideration in the

allocation of power resources by Central Control. Coordination with the Pump Operations Supervisor occurs reactively when priority issues arise under specific conditions.

#### **4.7. TURBINE GENERATOR #1 ELECTRICAL FAULT**

##### **4.7.1. INCIDENT SYNOPSIS**

On August 9, 2017 at 7:58 PM Turbine Generator # 1 (G1) lost voltage. Central Control notified Station D to start frequency changers #3 and #4 to replace the power lost by the shutdown of G1 since no other 25 Hz turbine generators were operational. Central Control notified the electric shop of the issue. At 9:00 PM, an electrician reported to Central Control that there was a problem with the field rheostat. The Central Control supervisor notified the S&WB Executive Director of the G1 outage.

S&WB electricians found that arcing occurred on the rotating arm which varies the field voltage in manual mode of operation. Arcing destroyed a portion of the rheostat contact plate, rotating arm, wiring and mount board. S&WB maintenance staff fabricated components to replace the failed equipment and work was completed at 6:00 PM, on August 10. G1 was brought back on line and load was separated from frequency changer #4 at 7:03 PM.

The rheostat is located in the cabinet shown in Figure 15. Damage to the field rheostat is shown in Figure 16. Arcing at the contacts of the brushes on the end of the rotating arm resulted in the destruction of brushes, wiring and limit switches. Two areas of the G1- rheostat insulating board were burned at the end of the rheostat arm under the conducting brushes and at the connector strip near the F#1 and F#2 connection points.



**Figure 15 Location of Field Rheostat**



**Figure 16 Damage to Field Rheostat**

Interviews were conducted with electricians who inspected and repaired the G1 rheostat. The electricians indicated they had not observed this type of rheostat failure previously. A review of the Central Control logs (Appendix K) showed that this was not the case. Another issue with the G1 field rheostat had occurred on July 9, 2017. The log indicates the field rheostat wouldn't "lower" and was likely frozen in place. The electrician who performed the work on July 9 indicated he found the rotating arm was sticking. He inspected the unit, observed pitting beneath the brushes on the rotating arm of the field rheostat and then sanded the contact plates (switching segments) and applied grease. He observed that the brushes were acceptable to continue using but did not indicate how what criterion was used to make this determination. He did indicate that pitting in brushes was observed from time to time and was not uncommon. After servicing the unit, the rotating arm was again able to rotate without sticking.

The rheostat was inspected on July 28 when G1 was brought down for other reasons. No rheostat testing was conducted at this shutdown. No further issues were discovered until August 9 when severe arcing occurred on the rotating arm and G1 lost field.

During the period when interviews were being conducted, a similar failure occurred. On April 26, 2018, voltage on G1 dropped at 7:26 AM. FC #4 at Station D was brought on line. High lift notified Central Control that the field rheostat had burned out. The Central Control log entry at 9:35 AM indicated that the exciter breaker and main breaker did not trip on G1. Electricians began repair of the rheostat shortly thereafter and were completed at 2 PM and High Lift notified Central Control.

#### **4.7.2. GENERATOR FIELD CONTROL**

The output voltage of the generator results from the number of conductors connected in series mounted in slots on what is known as an armature. Those conductors connected in series are called windings. A second part of the generator is the field, which is made up of North and South alternating

electromagnets. The field magnetizes the generator air gap. The intensity of the magnetic field, the velocity of the armature conductors moving through the magnetic field and the number of those armature conductors in series results in a voltage. G1 has two sources to control the generator's field, MANUAL and AUTOMATIC. The mode of operation is selected by D.C. circuit breakers.

The two sources for G1's magnetic field are; (1) a direct current rectifier or battery supply, for MANUAL operation and (2) a field exciter, for AUTOMATIC operation. The MANUAL control is only used in emergencies.

To raise or lower the generator's output voltage the field current is raised or lowered. In MANUAL operation, generator output change is accomplished by increasing or decreasing the rheostat's resistance in the generator's field circuit. As rheostat resistance increases, the voltage across the generator field drops and therefore the generator voltage drops. When rheostat resistance is decreased, the voltage across the generator field increases and the generator voltage rises.

The rheostat has a rotating arm that makes contact with a number of switching segments mounted on the rheostat's insulated board. The rotating arm is also insulated and is allowed to rotate about 330 mechanical degrees. A small electric motor drives the rheostat's arm in either a CW or CCW direction. The rheostat arm is limited in movement by both mechanical interference and by limit switches. A set of insulated brushes are mounted at both ends of the rheostat arm. One set of brushes is in contact with a ring of brass conductors and the other in contact with conductive and segmented switching elements. The two sets of brushes are connected in such a way as to allow for a change in resistance across the rheostat

#### **4.7.3. INVESTIGATION**

On May 17, 2018, a contractor from Industrial Electrical Services (IES) examined the rheostat along with S&WB electricians. They discovered that the rheostat had been wired incorrectly. The conductor for the manual mode rheostat was carrying full load current when the field exciter was in the automatic mode. The one-line diagram for the rheostat is shown in Figure 17 . Current would not normally be flowing through the manual rheostat in automatic mode because the breaker is opened and interlocked with the automatic mode breaker. Figure 18 shows the location of the rheostat connection in the mis-wired configuration.

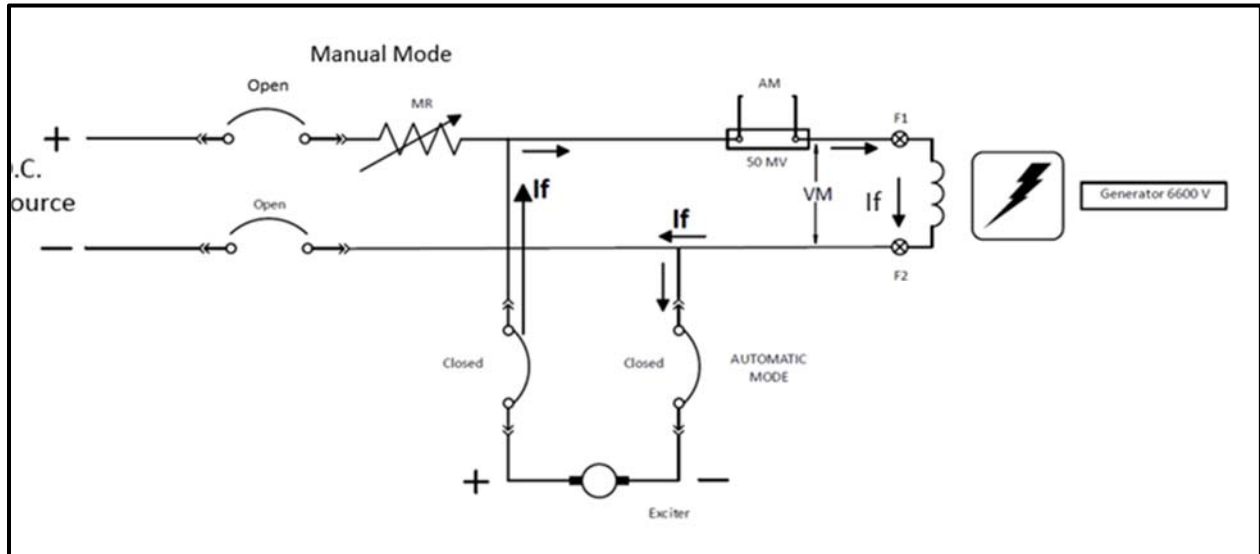

**Figure 17 One-Line Diagram for Field Rheostat**

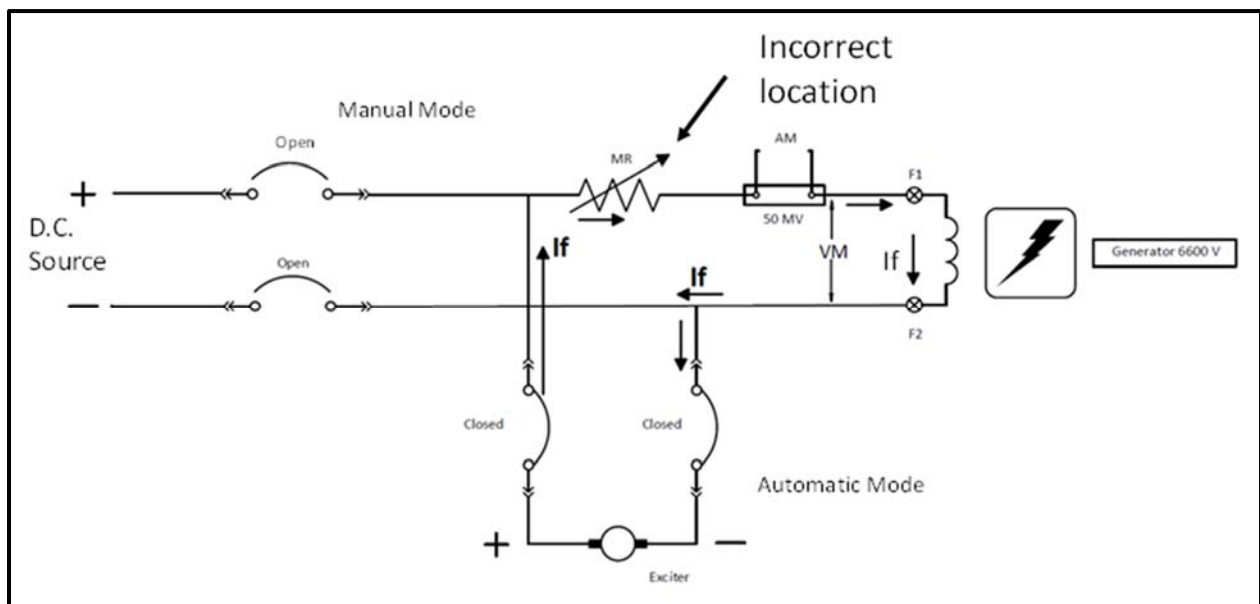

**Figure 18 One Line Diagram With Incorrect Wiring for Field Rheostat**

Electricians indicated that the wiring configuration found on May 17, 2018 was the configuration that had been used in the recent past. It is not known when the unit was first wired incorrectly. The installation error was only discovered because the unit failed in a similar manner previously, the previous incident in August 2017. The staff concluded that the unit should not have failed this frequently. G1 was used sparingly in the past when more turbines were operational reducing the possibility of additional rheostat failures. The potential for rheostat failure was less likely due to limited G1 run time.

The wire, cable leads to the rheostat and the rheostat were designed to carry rated generator field current. The installation error required the rheostat to carry current at all times, that is, when G1 is

operated in both manual and automatic modes. This installation error should not have caused the rheostat to fail. Photos of the damage as from the failure on August 9, seen in Figure 19 show significant arcing at the end of the rotating arm. The arm contains brushes which conduct from the arm to the contact plates.



**Figure 19 Field Rheostat Damage August 9, 2017**

**4.7.4. G1 RHEOSTAT REPAIR DATA**

Shop tickets for repairs on G1 rheostat are shown in Table 12. No shop tickets were available for the work maintenance work done on July 10, 2017 or on May 17, 2018. Work orders for the G1 field rheostat in August 2017 and April 2018 are shown in Table 13. No work orders were available for August 9-10, 2017 or April 26 - 27, 2018.

**Table 12 Shop Tickets for Turbine Generator #1 Field Rheostat**

Date	Ticket No.	Assigned To	Man-hours	Description	Notes
8/9/17	ES2017 A014896		15.5	#1 Turbine Not Working	Troubleshoot and found rheostat burned up
8/10/17	ES2017 A014899		39.5	Rebuild burned rheostat	Disconnected old rheostat and began rebuilding new rheostat board
8/10/17	ES2017 A014898		81	Rebuild rheostat for #1 Turbine	Continued rebuilding rheostat, reconnected and tested for proper operation
4/4/18	ES2018 A016303	Justin H.	2	Clean rings on Turbine #1	Clean rings and check brushed
4/19/18	ES2018 A016414	Justin H.	16	Connect feed to 480 panel	Reconnect 480 feeds to panel by Turbine 1
4/26/18	ES2018 A016462	Riley	5	Troubleshooting Turbine 1	
4/26/18	ES2018 A016464	Justin H.	14	Remove and repair rheostat	Remove damaged board, [replace] with new one
4/27/18	ES2018 A016473	Justin H.	12	Repair field rheostat	

**Table 13 Work Orders for Turbine Generator #1 Field Rheostat**

Date	Time	Project No.	Completed By	Activity	Action Taken
7/10/17	8:16	2017400442	H. Dimel	Repair Equipment	Replaced copper brushes, tested ok
5/17/18	11:08	2018200774	Harry and Bobby		Rewired field circuit for #1 Turbine rheostat



**5. ANALYSIS**

**5.1. RAINFALL**

Extensive analysis of the August 5 rainfall has been conducted by the National Weather Service (NWS) (Lincoln 2017). This analysis includes determination of localized and average rainfall rates and totals for each drainage basin. Rainfall was determined by radar data supplemented by public and private weather station data. There was an extreme variation of rain across the city with peak rainfall recorded for the August 5 event at 9 inches in a 3-hour period. To understand how unusual this storm was and how it compares with historical storms, rainfall totals by duration are categorized by a Precipitation Frequency Estimate (PFE) recurrence interval. This indicates the annual chance of occurrence for based on rainfall total and duration. Duration of the rainfall is important for establishing the recurrence interval of the event.

The rainstorm on July 22 occurred over approximately 3 hours. Rainfall over this period has a much longer recurrence interval than if the rain occurred over 24 hours. A comparison of the July 22 rainfall total as a 24-hour and as a 3-hour event is shown in Table 14.

**Table 14 July 22 Rainfall**

DPS	24-hr rainfall total (in)	24-hr event	If rain total occurred as 3-hr event
DPS 1	2.24	<3 mo. event	<1 yr. event
DPS 2	3.94	<1 yr. event	<5 yr. event
DPS 3	3.04	<6 mo. event	<2 yr. event
DPS 4	3.31	<3 mo. event	<5 yr. event
DPS 6	4.06	<1 yr. event	=5-yr event
DPS 7	4.69	= 1-yr event	<10 yr. event
DPS 12	-		
DPS 17	.38	<1 yr. event	<1 yr. event
DPS 19	-		

**5.1.1. AUGUST 5, 2017 EVENT**

Rainfall rates across individual drainage basins, rather than single-point data from DPS stations, better indicate drainage demand for the basins as a whole. Lincoln’s bias-corrected rainfall estimates <sup>7</sup> are shown in Table 15. Bracketing of the recurrence intervals are shown in Table 16. Recurrence intervals and PFE for August 5 event are shown in Table 17. Average rainfalls by basin is shown spatially in Figure 20. Average recurrence intervals for 3 hours bias-corrected storm for August 5 are shown in Figure 21.

<sup>7</sup> Lincoln, W. Scott, *Rainfall Analysis for the August 5, 2017, New Orleans Flash Flood Event*, National Weather Service, October 12, 2017

**Table 15 August 5 Average Rainfall by Drainage Basin**

Drainage Basin	Average rainfall in basin (inches), 13:00-19:00	Average recurrence interval of PFE (6 hr.)
DB1	2.3	<1 yr. event
DB 2	6.1	>10 yr. event
DB 3	7.8	>25 yr. event
DB 4	2.9	<1 yr. event
DB 6	3.2	<1 yr. event
DB 7	5.6	>5 yr. event
DB 12	3.4	<1 yr. event
DB 17+19	6.0	>10 yr. event

*Bias-corrected 6-hr rainfall data is from GIS supplied to ABS Group by W. Scott Lincoln (NWS); drainage basin boundaries are as defined by CDM.*

**Table 16 August 5 Average Rainfall and Recurrence Intervals**

Drainage Basin	Average rainfall in basin (inches), 13:00-19:00*	Average recurrence interval (ARI) of PFE (6 hr.)	Bracketing 6-hr event (inches) for ARI	Bracketing 6-hr event (inches) for ARI
DB1	2.3*	<1 yr. event	6-mo. event = 2.6	1-yr. event = 3.45
DB 2	6.1*	>10 yr. event	10-yr event = 5.96	25-yr event = 7.62
DB 3	7.8	>25 yr. event	25-yr event = 7.62	50-yr event = 9.11
DB 4	2.9	<1 yr. event	6-mo. event = 2.6	1-yr. event = 3.45
DB 6	3.2*	<1 yr. event	6-mo. event = 2.6	1-yr. event = 3.45
DB 7	5.6	>5 yr. event	5-yr event = 4.95	10-yr event = 5.96
DB 12	3.4	<1 yr. event	6-mo. event = 2.6	1-yr. event = 3.45
DB 17+19	6.0	>10 yr. event	10-yr event = 5.96	25-yr event = 7.62

*\* Numbers shown are averages for NWS bias-corrected rainfall estimates within basins derived from GIS and exceed some maximum rain gauge values observed during the event within these basins. Bias-corrected 6-hr rainfall data is from GIS supplied to ABS Group by W. Scott Lincoln (NWS); drainage basin boundaries are as defined by CDM; PFE and ARI data values are from NOAA.*

**Table 17 Recurrence Intervals and Precipitation Frequency Estimates for August 5 Event**

<b>Drainage Basin</b>	<b>Average recurrence interval (ARI) range within basin (6 hr.)</b>	<b>(6 hr.) PFE for minimum ARI (inches)</b>	<b>(6-hr) PFE for maximum ARI (inches)</b>
DB1	<2-yr to 5-yr	<3.29	4.07*
DB 2	<2-yr to 50-yr	<3.29	7.27*
DB 3	2-yr to 100-yr	3.29	.855*
DB 4	<2-yr	<3.29	
DB 6	<2-yr to 10-yr	<3.29	4.86*
DB 7	<2-yr to 25-yr	<3.29	6.14
DB 12	<2-yr	<3.29	
DB 17+19	5-yr to 50-yr	4.07	7.27*
<p><i>*Numbers shown are at median of 90% confidence interval for NWS bias-corrected rainfall estimates</i></p> <p><i>ARI estimates are from W. Scott Lincoln (NWS); drainage basin boundaries are as defined by CDM; PFE and ARI data values are from NOAA.</i></p>			

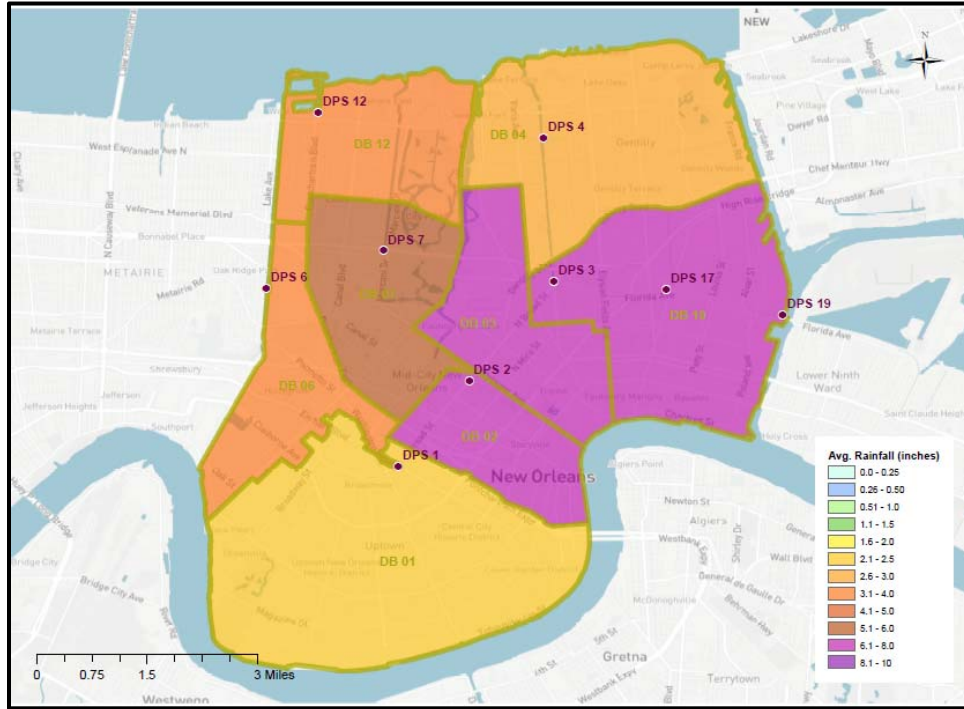

**Figure 20 Average Rainfall By Drainage Basin August 5**

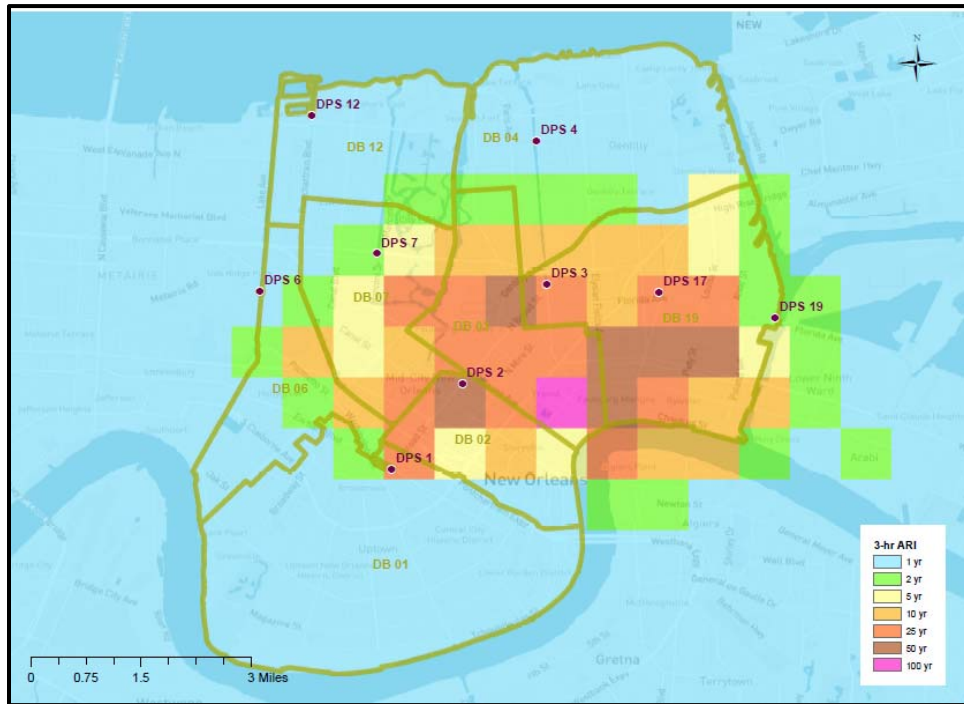

**Figure 21 Average Recurrence Interval (NWS) 3 Hours August 5**

*DB 1.* Lincoln's meteorological analysis of the August 5 event indicated relatively less intense rainfall over most of DB 1, which received from 1.0 to 2.5 inches of rain between 1:00 PM and 7:00 PM. The northern and eastern edge of the basin, in proximity to DB 6, DB 7 and DB 2, received from 3 to 4 inches between 1:00 PM and 7:00 PM. Lincoln's analysis indicated that over most of DB 1, the August 5 event was a less-than-2-yr (3-hr) event, that is, there was a greater than 50% chance of such an event occurring in a 3-hr period, each year.

*DB 2.* Lincoln's analysis of August 5 indicated intense rainfall over most of DB 2, which received from 3.0 to 8+ inches of rain between 1:00 PM and 7:00 PM. The northern area the basin received the greatest quantity of rainfall between 1:00 PM and 7:00 PM. The rain gauge at DPS 2 recorded 9.43 inches of rain in the time interval between about 1:30 PM (when the rain started) and 10:36 PM (when it ceased), the highest rainfall observed at any DPS on August 5. The most intense hour of rainfall (on the hour) at DPS 2 was between 3:00 PM and 4:00 PM; the rain gauge measured a rainfall of 3.09 inches in that hour. Maximum rate of rainfall was 3.69 inches in 60 minutes. Lincoln's analysis indicated that the August 5 event in DB 2 ranged from a less-than-2- yr. (3-hr) event (a greater than 50% chance of such a 3-hr event occurring each year) near the Mississippi River to a 50-yr (3-hr) event (2% chance of occurring each year) near DPS 2.

*DB 3.* Lincoln's meteorological analysis of August 5 indicated intense rainfall over most of DB 3, with particularly dense rainfall in a band stretching from the Fair Grounds to the 7<sup>th</sup> Ward. This area of heaviest rainfall received 8+ inches of rain between 1:00 PM and 7:00 PM. DB 3 had a larger area of this maximum 8+ inches of rainfall than did any other drainage sub-basin. The rain gauge at DPS 3 (just outside Lincoln's identified area of heaviest rainfall) recorded 5.54 inches of rain fell between about 1:30 PM and 11:00 PM. The most intense hour of rainfall at DPS 3 (on the ½ hour) was between about 3:30 PM and 4:30 PM, when the rain gauge measured 2.8 inches falling in that hour (ABB time corrected by +2:05). Lincoln's analysis indicated that the August 5 event in DB 3 ranged from a less-than-2-yr (3-hr) event (a greater than 50% chance of such an event occurring each year) near the boundary of DB 4 to a 100-year (3-hr) event (1% chance of occurring each year) in the Faubourg Marigny. In much of central DB 3, it was a 25-year (3-hr) event (4% chance of occurring each year).

*DB 4.* Analysis of the August 5 event indicated the northern part of DB 4 received from 1 to 2.5 inches of rain between 1:00 PM and 7:00 PM with more intense rainfall in the southern part of the basin. The heaviest rainfall in DB 4 occurred in proximity to the boundary with DB 3, where a small area of the DB 4 sub-basin received about 5 inches of rain between 1:00 PM and 7:00 PM. Lincoln's analysis indicated that the August 5 event in most of the DPS 4 sub-basin was a less-than-2-yr (3-hr) event, that is, there was a greater than 50% chance of such an event occurring each year, with greater intensity of rainfall at the southern edge of the sub-basin near the DB 3 and DB 17 and DB 19 boundaries.

*DB 6.* Analysis of the August 5 event indicated the southern part of DB 6 received from 1 to 2.5 inches of rain between 1:00 PM and 7:00 PM, with more intense rainfall in the central part of the basin and west to Hoey's basin in Jefferson Parish. The heaviest rainfall in DB 6 occurred in proximity to the boundary with DB 7, where a small area of DB 6 received up to about 4 inches of rain between 1:00 PM and 7:00 PM. Lincoln's analysis indicated that the August 5 event in most of the DPS 6 sub-basin was a less-than-2-yr (3-hr) event, that is, there was a greater than 50% chance of such an event occurring each year, with greater intensity of rainfall at the edge of the sub-basin near the boundary of DB 7 boundary.

*DB 7.* Analysis of the August 5 event indicated much of DB 7 received intense precipitation. Most of the basin received 3 inches or more of rain between 1:00 PM and 7:00 PM, with much of it receiving from 4 to 6 inches, with the far eastern edge (in proximity to DB 3) receiving 8 inches of rain between 1:00 PM and 7:00 PM. A private rain gauge within DB 7 recorded 9.7 inches of rainfall on August 5. Lincoln’s analysis indicated that the August 5 event in DB 7 was a less-than-2-yr (3-hr) event (a greater than 50% chance of such an event occurring each year) at the northern edge of the basin, but with generally increasing intensity in the eastern and southern portions of the basin. Rainfall reached its greatest intensity at the boundaries of DB 2 and DB 3, where the rainfall was at the level of a 25-year (3-hr) event (4% chance every year).

*DB 12.* Analysis indicated a large part of DB 12 received 3 or more inches of rain between 1:00 PM and 7:00 PM. The rain gauge recorder at DPS 12 showed only .37 inches of rain on August 5 (with no change after 1:18 PM. Given rain elsewhere in New Orleans and the level variation of the DPS 12 suction basin (discussed below), the DPS 12 rain gauge was very likely malfunctioning and Lincoln evidently did not use it as a source of data. According to Lincoln’s analysis, the August 5 event in the entirety of DB 12 was a less-than-2-yr event (3-hr), that is, there was a greater than 50% chance of such an event occurring each year.

*DB 17+19.* Lincoln’s meteorological analysis indicates that most of DB 17 and 19 received heavy rainfall, with 6+ inches falling between 1:00 PM and 7:00 PM in a large area of the basin and the most intense rain reaching 8+ inches in the St. Claude neighborhood. The DPS 17 rain gauge recorded 5.28 inches of rain between 1:00 PM and 7:00 PM; 2.9 inches fell between 3:00 PM and 4:00 PM. Lincoln’s analysis indicated that the August 5 event in DB 17 and 19 ranged from a 10-yr event (3-hr) (10% chance of such an event occurring each year) to a 50-year event (3-hr) (2% chance every year) across much of the central part of the sub-basin and along the boundary with DB 3.

**5.2. FLOODING CLAIMS AND DAMAGE ASSESSMENT**

**5.2.1. 911 EMERGENCY CALLS**

911 calls are an important indicator of flooding. Many calls are related to rising water in underpasses. When these calls are taken out, a more accurate picture of flooding is available which can be used to alert the public of areas to avoid. Table 18 below provides the number of calls by drainage basin for each of the three Loss Event dates. Distribution of these calls over time is shown in Figure 22 and Figure 23.

Calls to 911 began about 45 minutes after the rain started on August 5. This was well before official advisories were issued by city agencies or the National Weather Service. 911 call reports should be monitored by NOHSEP and used to develop public notifications.

**Table 18 911 Calls**

Date	DB 01	DB 02	DB 03	DB 04	DB 06	DB 07	DB 12	DB 19
7/22/2017	2	3	6	1	0	3	0	2
8/5/2017	0	21	54	1	5	30	8	21
8/8/2017	0	0	0	0	0	0	0	0

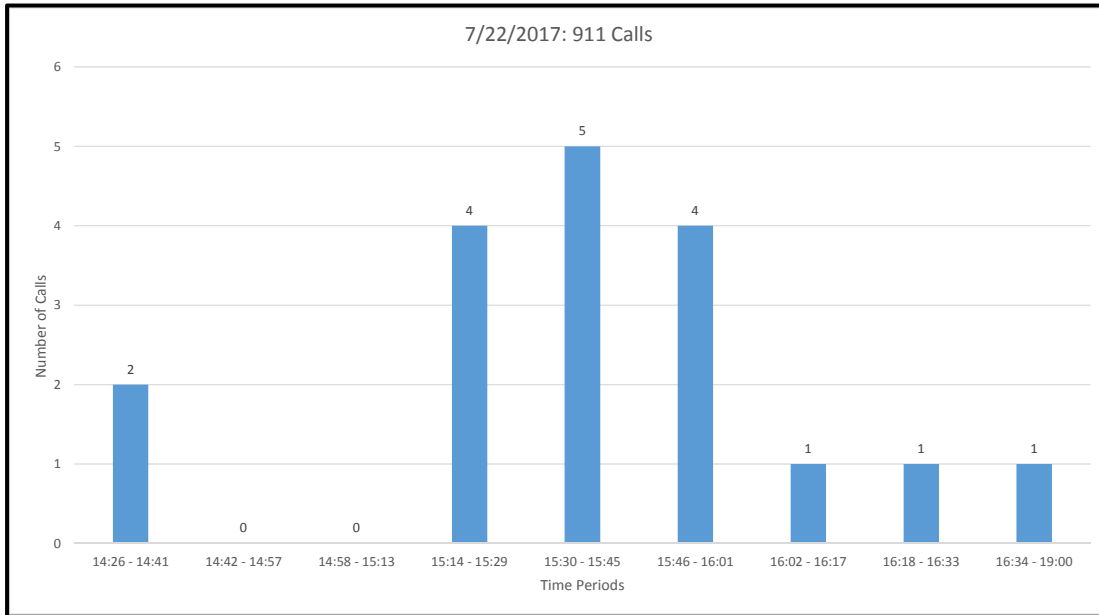

Figure 22 911 Calls July 22

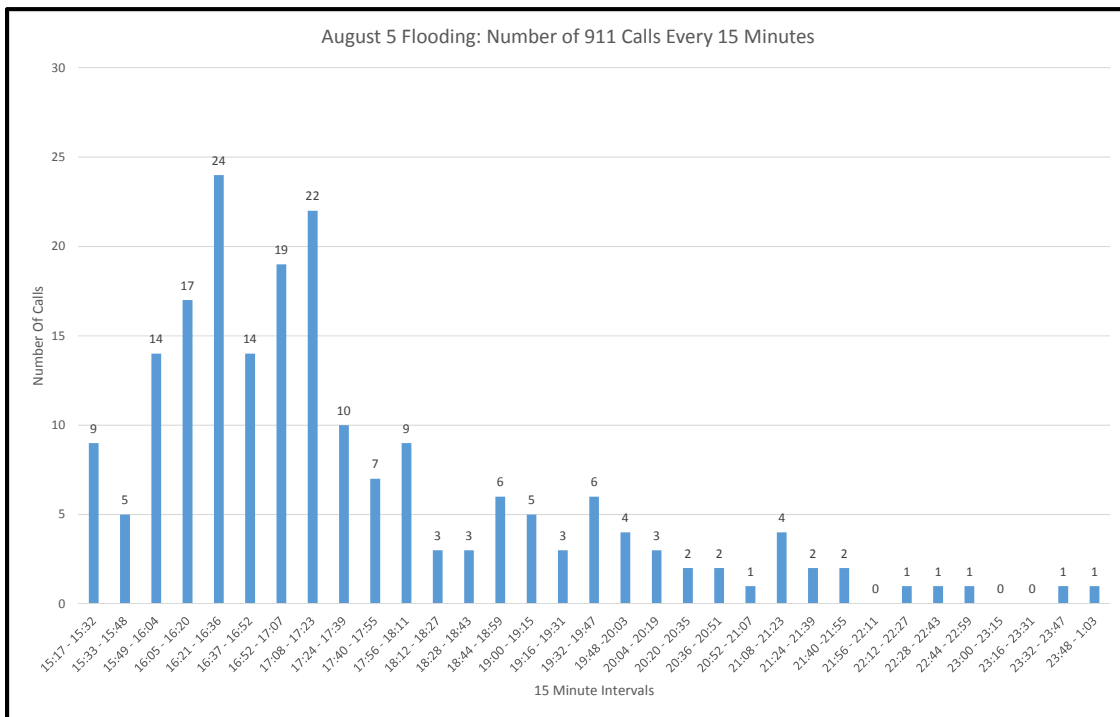
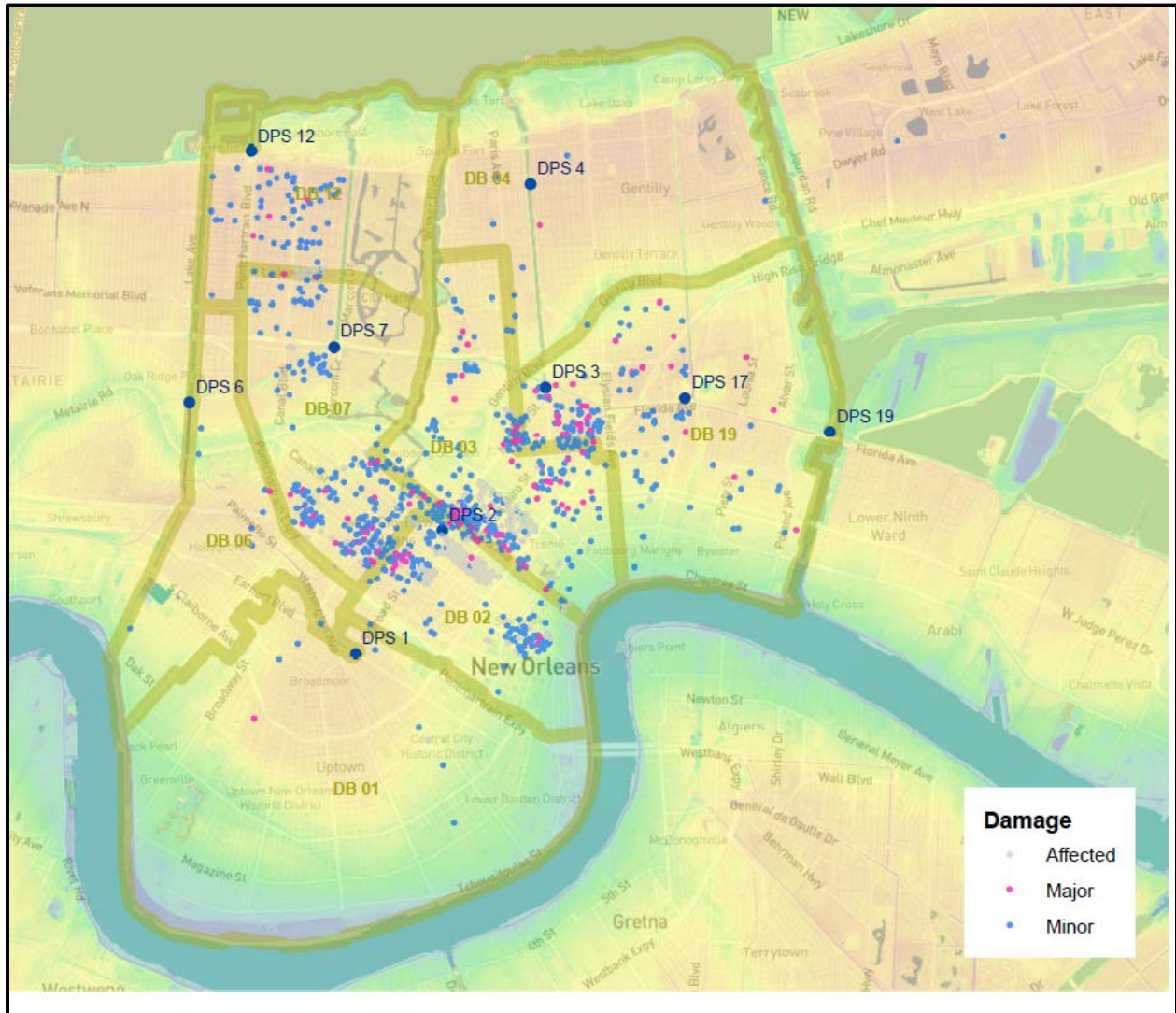

Figure 23 911 Calls August 5

**5.2.2. FLOOD DAMAGE ASSESSMENT**

The NOHSEP damage assessment database indicates there were 151 properties with major damage and 829 properties with minor damage. All drainage basins had at least some damage reports. Mid-City, St. Bernard, City Park, West End and Bywater had reports with major damage. A plot of damage levels is shown in Figure 24.



**Figure 24 NOHSEP Flood Damage Assessment August 5 Event**

Participants in the National Flood Insurance Program (NFIP) who incurred flood damage filed a total of 681 claims. A total of 221 of these have been paid for a total of \$4.3 million. The number of claims by drainage basin is shown for each flood event in Table 19. A plot of NFIP claims is shown in Figure 25.



**Table 19 Number of NFIP Flood Claims**

Date	DB 01	DB 02	DB 03	DB 04	DB 06	DB 07	DB 12	DB 19	Totals
7/22/2017	0	3	2	0	1	5	0	0	11
August 5/2017	6	137	165	8	11	224	20	110	681
8/8/2017	0	0	0	0	0	0	0	0	0

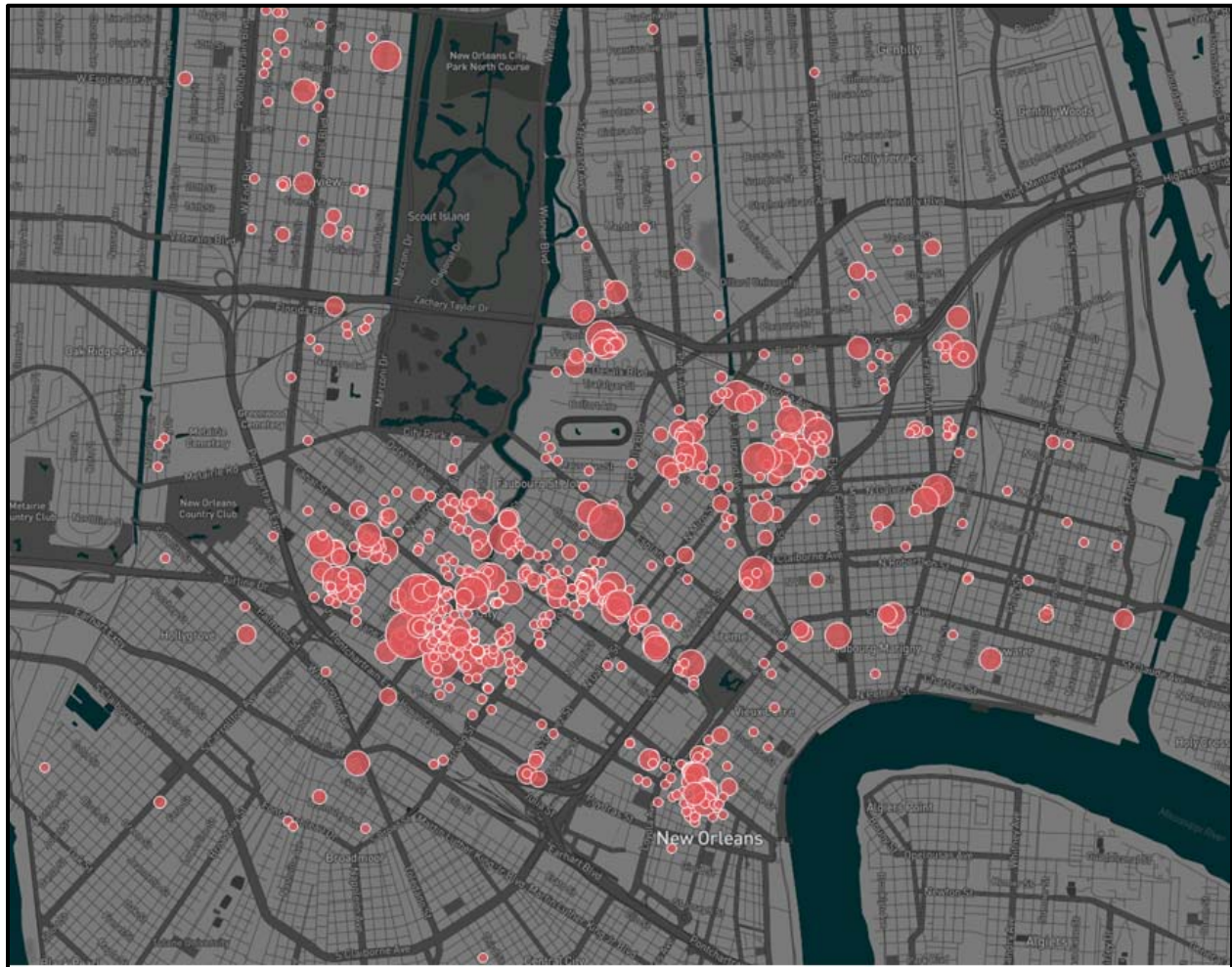

**Figure 25 NFIP Claims Distribution**

**5.2.3. USACE CONSTRUCTION IMPACT ON FLOODING**

Previous to the August 5 event, the US Army Corps of Engineers (USACE) had removed two approximately 70-ft sections of sheet pile along the top of the Peoples Avenue Canal (west side) in advance of SELA project construction to connect new box culverts along Treasure and Benefit streets to the Canal. The USACE stated after the event that removal of the sheet pile sections had lowered pre-

event flood risk reduction in the vicinity and may have contributed to flooding south of Gentilly Boulevard, in DB 19. No damage claims were reported to NFIP or NOHSEP in DB 4 in proximity to the Peoples Avenue Canal and any overtopping of the Peoples Avenue Canal in DB 17 and DB 19 had no impact in DB 4.

Residents in DB 19 reported flooding in the vicinity of the Peoples Avenue Canal (or Peoples Canal) on August 5 and reported possible overflow from the canal and/or at a USACE construction site along the Canal. The Peoples Canal runs parallel to and east of Peoples Avenue from near Lake Pontchartrain toward Florida Avenue, transecting DB 4 and DB 19. Gentilly Boulevard (US Highway 90) follows Gentilly Ridge and is the boundary of DB 4 and DB 19; the Peoples Canal has a summit at Gentilly Boulevard and thus drains both north to DB 4 and south to DB 19. From south of Gentilly Boulevard to DPS 17, the Peoples Avenue Canal is an open and unlined drainage canal. From North of Gentilly Boulevard the canal is an underground culvert. Location of the most significant flooding is shown in Figure 26

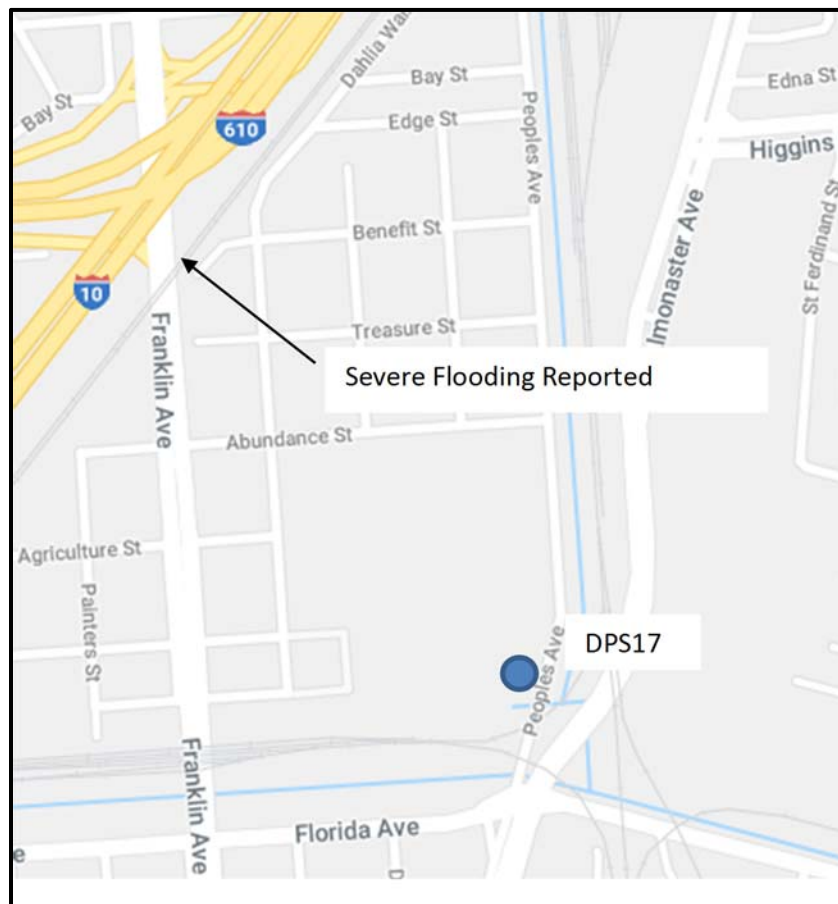

**Figure 26 Location of Flooding Near Peoples Avenue Canal**

The outlet of the Peoples Canal to DPS 17 and the DPS 17 suction basin are at the eastern end of the pumping station; the small drainage pumps at DPS 17 (combined, 300 cfs) discharge to the Florida Avenue Canal via an underground discharge basin to the south of the station. In addition, there is a bypass channel from the Peoples Avenue Canal to the Florida Avenue Canal, which passes beneath the

Almonester Avenue overpass. This bypass channel is under reconstruction as part of the SELA-20 project at the time of the August 5 incident.

Much of DB 17 and DB 19 received intense rainfall on August 5 and severe flooding occurred within the basin, with several feet of standing water reported near the intersection of Franklin Avenue and Benefit Street. The underpass is located approximately .82 miles south of the summit of the Peoples Avenue Canal at Gentilly Boulevard and .37 miles northwest of DPS 17. Where Franklin Avenue passes under the CSX railroad track south of I-10/I-610, the S&WB maintains and operates a 24-cfs underpass pump. As much as five feet of water was reported to have accumulated in the underpass area on August 5. However, NOHSEP and NFIP flood damage reports in the vicinity are mostly for minor damage with a maximum reported residential flood damage depth in the area of less than 2 ft.

The S&WB stated after the August 5 event that the Peoples Avenue Canal was full but did not overtop during the event. Although DB 17 and DB 19 as a whole has pumping capacity redundancy fairly typical of Old City drainage basins (see Table 7), DPS 17 is centrally located within its basin and must lift water draining from a sub-basin within an area bounded by hydrologic barriers, namely Gentilly Boulevard, Elysian Fields Avenue, the Norfolk Southern Railroad tracks and the Mississippi River. A cross-basin connection exists at St. Claude Avenue, so the portion of the sub-basin to the River side of St. Claude likely drains directly to DPS 19. The Peoples Canal bypass channel into the Florida Avenue Canal would normally divert water to DPS 19 but was evidently closed during the August 5 event. It is not known if on August 5 the bypass channel was closed and if so whether it potentially could have raised water levels in the Peoples Avenue Canal to the north of the channel leading to the DPS 17 suction basin.

Previous to the August 5 event, the USACE had also removed two approximately 70-ft sections of sheet pile along the top of the Peoples Avenue Canal (west side) in advance of SELA project construction connecting new box culverts along Treasure and Benefit streets to the Canal. The USACE stated after the event that removal of the sheet pile sections had lowered pre-event flood risk reduction in the vicinity and may have contributed to flooding. If the Peoples Avenue Canal was overtopped at this location of sheet pile gaps, runoff would have likely sought to flow into the Franklin Avenue underpass (in addition to precipitation in the immediate area of the underpass), adding to flooding in that vicinity. Following the August 5 event, the USACE undertook to restore the previous level of flood risk reduction along the Canal with an earthen berm and other measures and requested that citizens who thought the construction work had contributed to flood losses contact the USACE to make a claim. The outcome of any flood claims made as a result of USACE construction activities at the Peoples Avenue Canal is not known.

### **5.3. S&WB POWER SYSTEMS**

#### **5.3.1. ELECTRICAL POWER SOURCES**

Power is a key component to the function of the entire drainage system and power was a significant factor in the analyzed events. S&WB power generation system is comprised of five (5) turbine generators run by both steam and combustion. In-house dual fuel boilers provide steam and the local distribution supplier, Entergy, supplies natural gas. Both the steam boilers and the combustion turbines operate on either natural gas or diesel fuel. Turbines 1, 3, 4 and 5 produce 25 Hz electrical power and turbine 6, produces 60 Hz electrical power. The local distribution supplier Entergy also provides 60 Hz

power. There are 58 pumps (including constant duty) within the stations in the Old City and 42 pumps are powered by 25 Hz electrical power with four of the 10 stations, DPS 2, 3, 12 and 17, relying solely on 25 Hz power. Frequency changers include the Plant Frequency Changer, Carrollton Frequency Changer #1, Carrollton Frequency Changer #2, Station D Frequency Changer #3 and Station D Frequency Changer #4.

Overall layout of the feeder network connecting drainage pumping stations with power sources is shown in Figure 27. Diagrams depicting line up of specific power sources with pumps are included in Appendix E.

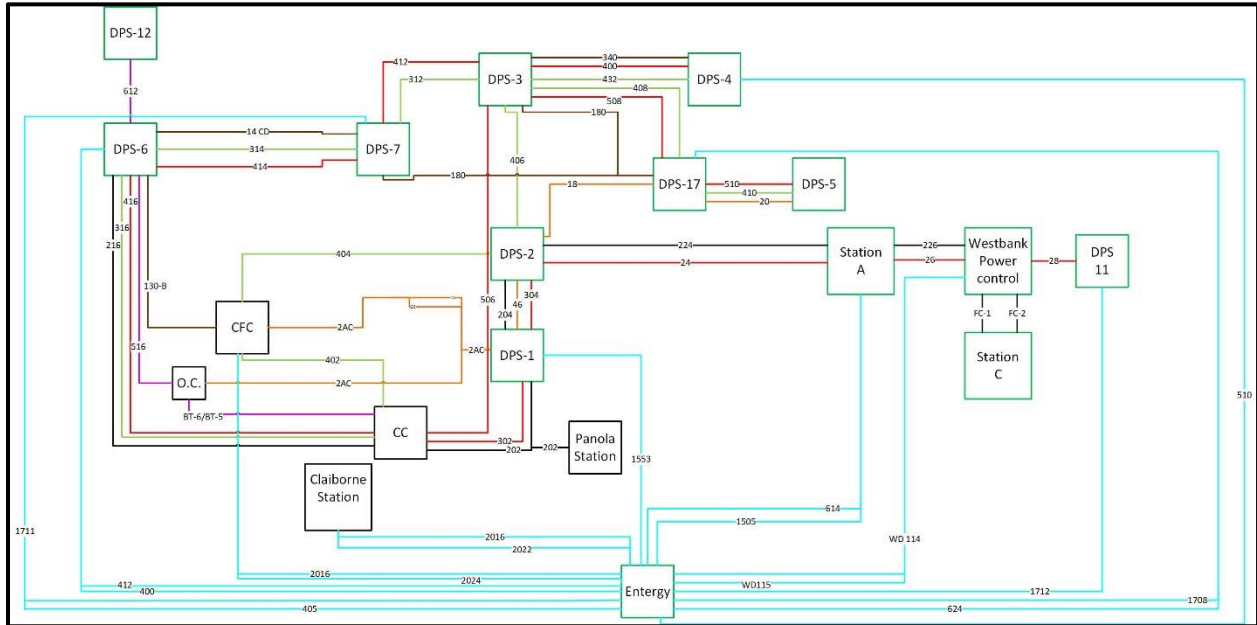

**Figure 27 Drainage Station Feeder Network**

**5.3.2. ENTERGY POWER SUPPLY**

Entergy power is utilized in the 60 Hz pumps or to a frequency changer where the power is converted from 60 Hz to 25 Hz. The four pump stations that Entergy directly supplies power to are DPS 1, 4, 5, 6, 7, 17 and 19. Figure 28 shows the power schematic for 60 Hz Entergy supply.

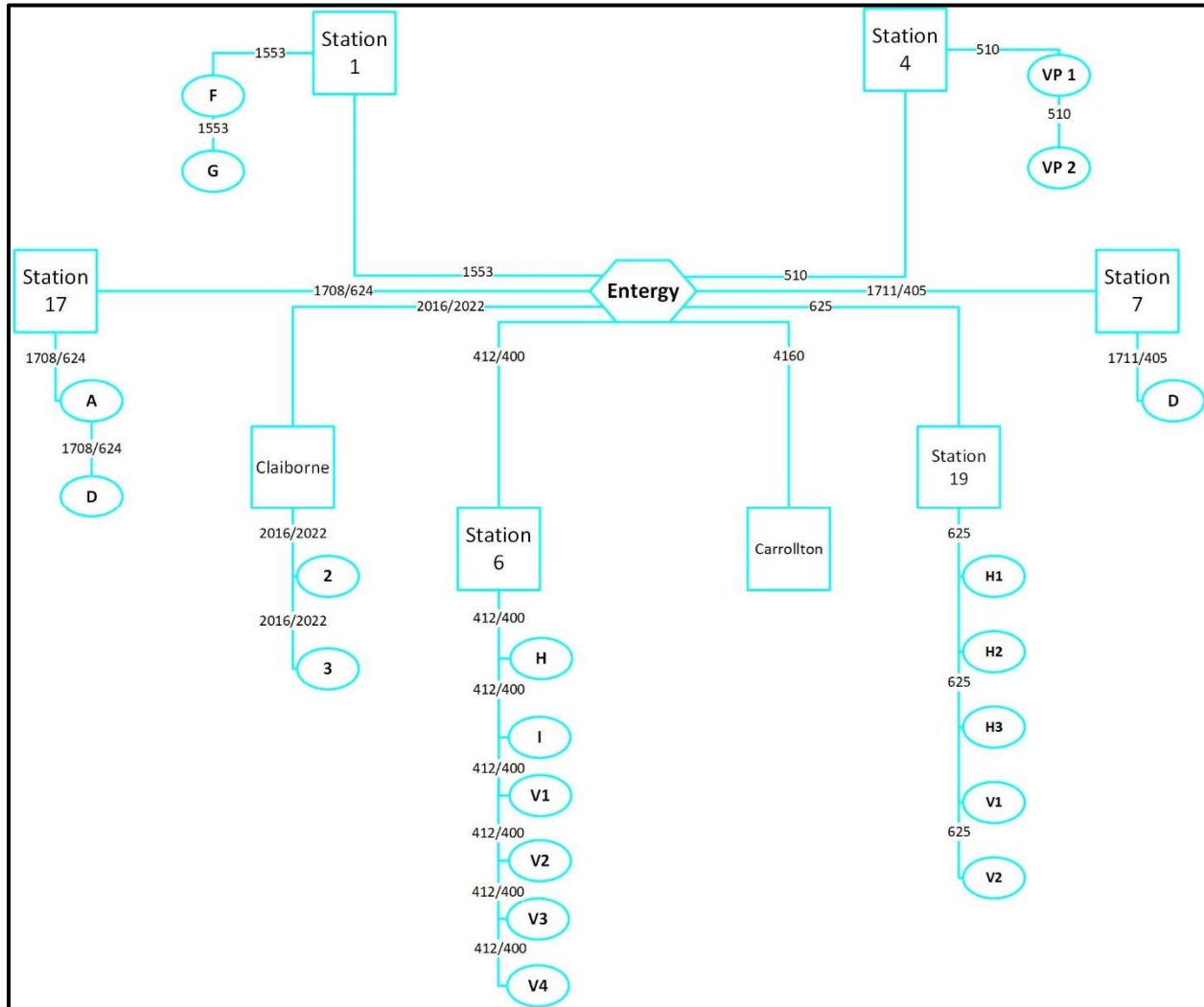

**Figure 28 Power Schematic for 60 Hz Entergy Power Supply**

S&WB receives Entergy power through overhead power lines. Overhead power lines are subjected to natural elements and are more likely to break or disconnect especially during a major rain/storm event. High wind, trees or limbs falling on the line or lightning are examples of how overhead lines can disconnect.

If Entergy has a surge of power that last for 3 seconds or less, they do not acknowledge it as a surge. This is critical to S&WB because any surge, no matter how fast, will stop a pump from running. Stopping a pump that is pumping water can cause major problems such as potable water pressure dropping too low causing a boil water advisory or drainage pumps can start running backwards bringing water back into the city rather than out of the city.

During separate interviews, a Central Control Supervisor and a former Superintendent both indicated that S&WB has had issues with short duration Entergy power outages. These brief outages cause the frequency changers at the Carrollton Frequency Conversion Station, where Entergy 60 Hz supplied power is converted to 25 Hz power, to trip and subsequently the 25 Hz supplied pumps to stop. Further

complicating this problem, according to S&WB interviews, is the lack of acknowledgement from Entergy of power outages lasting 3 seconds or less and therefore refusing to remediate the issue.

During the July 22, 2017 event, Drainage Pumping Station 3 experienced issues due to an Entergy power outage that lasted for 3 hours. This caused problems for frequency changer #4, subsequently causing problems for the feeders getting power to the pumps. Specifically, the operators were unable to load Pump C and Pump B ran backwards for duration of the Entergy power outage. There was also a 60 Hz Entergy power surges noted on August 8 rain event that caused a brief issue for DPS 7 and frequency changer #4.

Due to these issues, it was preferred to power the system internally, as much as possible, rather than relying on local distribution. In ideal conditions, the system can produce a maximum of 61 MW of 25 Hz power. However, the major power generation equipment is old, dating back 100 years. Portions of the system are in needs of major repairs and rehabilitation due to age and lack of proper maintenance throughout the years.

### **5.3.3. S&WB POWER AVAILABILITY**

After Katrina, Turbine 4 was the only turbine used to power the drainage pumps. The only option available to power the turbine was dirty steam because the storm destroyed the water cleaning system at the plant so the only steam available was produced by dirty water. Turbine 4 successfully powered the pumps, but the dirty steam critically damaged the turbine to the point that total reconstruction was required. Seven years later in January of 2012, Turbine 4 was removed for reconstruction.

The loss of Turbine 4 reduced the 25 Hz power from the system by 20 MW. This left the system with 41 MW of power. Other turbines had to be utilized more frequently to replace Turbine 4 while it was out of service. Operating condition of the other turbines were not adequate, and the extra utilization proved to be a problem. On March 9, 2017, Turbine 3 failed. This failure reduced the 25 Hz power by 15 MW leaving the system with 26 MW of 25 Hz power. Two days after the July 22, 2017 flood event on July 24, 2017 Turbine 5 failed. This failure reduced the 25 Hz power by 20 MW leaving the system with only Turbine 1 which produces a maximum of 6 MW of 25 Hz power. Turbine 1 was the only generator in working condition leading up to and during the August 5, 2017 event. Figure 29 is a graph created by Ch2M for an S&WB presentation on September 1, 2017 showing the change in available in power as each turbine went out of service.

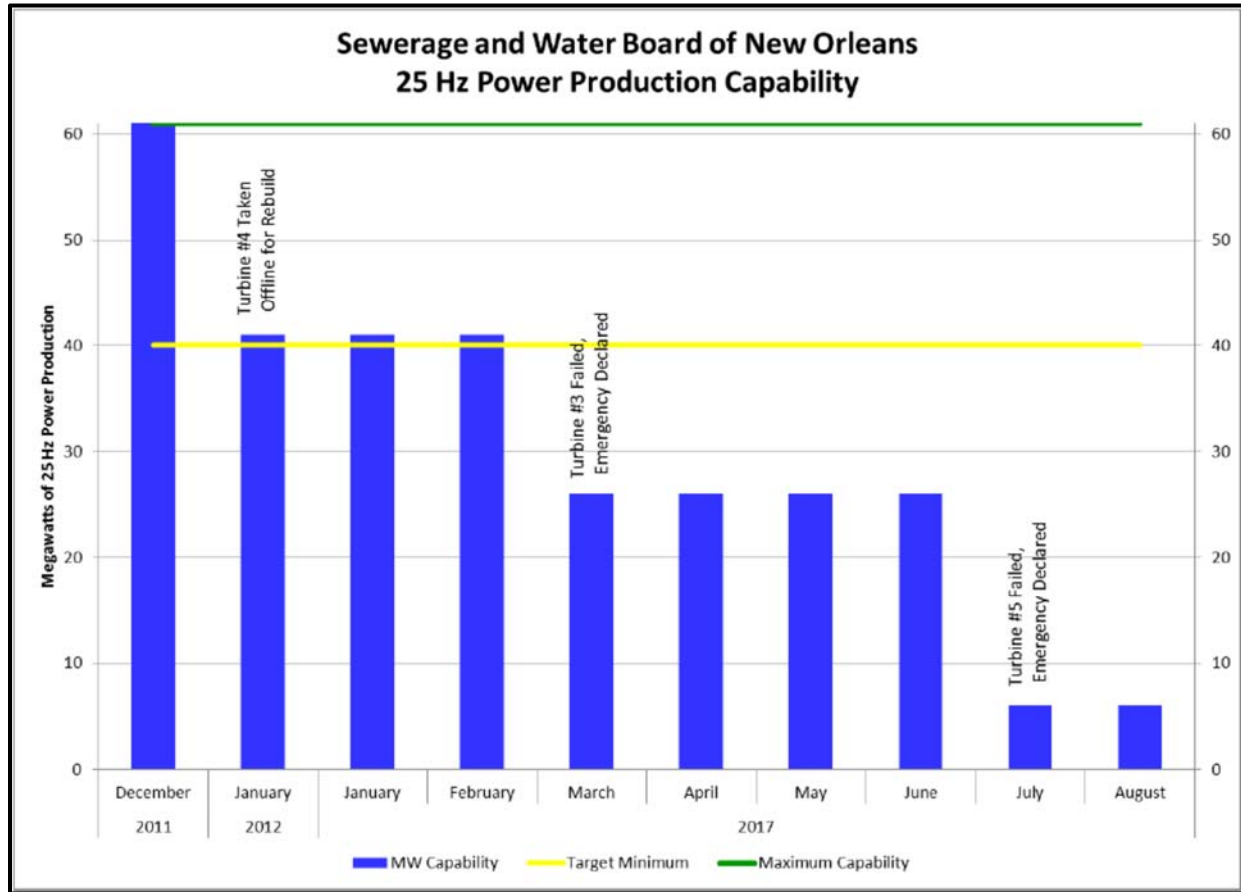

**Figure 29 25 Hz Power Production From S&WB Turbine Generators 2011-2017**

Out of the three events under consideration for this study, the August 5, 2017 event presented the most power availability issues. On that day, Turbine 1 provided a maximum of 5.2 MW of 25 Hz power. Frequency changers at Carrollton (8.5 MW), Plant (3.75) and Station D (12 MW) provided an additional 24.25 MW for a total of 29.4 MW at rated capacities for the frequency changers. The peak connected load is approximately 52 MW. The peak storm load is estimated to be 40 MW. Approximately 75% of that power level was available for use. In reality, there was less power available because the feeder network limits the ability to share power. Each pump has certain feeder paths over which to receive power. Additionally, power from frequency changers are not used in parallel. This prevented use of frequency changer #2 (2.5 MW) at Carrollton. The maximum power provided on August 5 was 13.3 MW based on data from logbooks. This is 33% of the peak storm load and represents a significant power deficiency for rain events.

The lack of power caused major problems throughout the system including Station D frequency changers #3 and #4 tripped offline causing pump failures at stations 1, 2, 3, 4 and 6. Operators at drainage pump station were continually refused requests by Central Control to turn on pumps due to the lack of power. DPS 2, 3, 4, 6, 7 and 12 experienced refusals of pumps even when the water was at and/or over flooding elevations. Throughout the event, 32% of pumping capacity was denied in DPS 2, 26% in DPS 3, 27% in DPS 4, 11% in DPS 6, 33% in DPS 7 and 100% in DPS 12. DPS 12 did not pump any

water out of its basin until 8:49 PM that evening, hours after the end of the storm because power was diverted to Station 6.

If power were available, significantly more water could have been pumped at critical times. It is possible that other pump denials were issued but were not recorded. Requests noted in station logbooks can be seen in Table 20 below.

**Table 20 Pump Start Denials**

<b>Time</b>	<b>Date</b>	<b>Log Location</b>	<b>Station</b>	<b>Requested Pump Start</b>	<b>Power (MW)</b>	<b>Pump Flow Capacity (cps)</b>
3:11 PM	8/5/2017	DPS	2	A	1.1	550
4:00 PM	7/22/2017	Central Control	2	D	2.0	1000
3:22 PM	8/5/2017	DPS	3	A or B	1.1	550
4:44 PM	8/5/2017	DPS	3	A, B, or E	2.0	550/1000
7:08 PM	8/5/2017	DPS	3	E	2.0	1000
4:20 PM	8/5/2017	DPS	4	D	2.0	1000
4:20 PM	8/5/2017	DPS	4	E	2.0	1000
4:25 PM	8/5/2017	DPS	4	Any Big Pump	2.0	1000
4:30 PM	8/5/2017	DPS	4	B	2.0	1000
5:13 PM	8/5/2017	DPS	6	A or B	1.1	550
3:02 PM	8/5/2017	DPS	7	A	1.1	550
3:16 PM	8/5/2017	DPS	7	A	1.1	550
3:21 PM	8/5/2017	DPS	7	A	1.1	550
7:55 PM	8/5/2017	DPS	12	D	2.0	1000

Total 25 Hz power generated and consumed was computed by McBride <sup>8</sup>for July 22 and August 5 Loss Events using logbook information. The July 22 analysis is shown in Table 21. The peak generated was 21.7 MW and peak used was 14.8 MW. Power generated on August 5 is shown in Table 22. Peak generation was 13.3 MW.

<sup>8</sup> Data developed by Matt McBride under contract to City of New Orleans



**Table 21 Power Generation and Consumption (kW) July 22, 2017**

G1	G5	FC3	FC4	Generated	Used	Balance total
3,116				3,116	130	2,986
3,256				3,256	340	2,916
3,396	12,420	1,000	800	17,616	1,250	16,366
3,423	14,360	2,000	-	19,783	4,250	15,533
3,450	16,300	2,000	-	21,750	8,190	13,560
3,392	14,725	2,000	-	20,117	12,810	7,307
3,333	13,150	2,000	-	18,483	14,770	3,713
3,264	11,635	2,000	-	16,899	13,780	3,119
3,195	10,120	2,000	-	15,315	12,530	2,785
2,584	8,328	800	-	11,712	7,230	4,482
1,972	6,536	800	-	9,308	2,360	6,948
1,046	5,462	800	-	7,307	2,400	4,907
119	4,387	800	-	5,306	2,340	2,966

**Table 22 Power Generation (MW) August 5, 2017**

	Turbine 1	PFC	CFC 1	CFC 2	SDFC 3	SDFC 4	Total
8/5/17 2:00 PM	3.9	0	0	0	0	0	3.9
8/5/17 2:30 PM	3.9	0	1	0	0	0	4.9
8/5/17 3:00 PM	3.8	0	1	0	1	4.6	10.4
8/5/17 3:30 PM	3.8	0	1	0	1	4.6	10.4
8/5/17 4:00 PM	4.2	0	1	0	1	4.6	10.8
8/5/17 4:30 PM	4.2	0	1	0	1.4	4.8	11.4
8/5/17 5:00 PM	5.0	1	1	0	1.4	4.8	13.2
8/5/17 5:30 PM	5.0	1	1	0	1.4	4.8	13.2
8/5/17 6:00 PM	5.1	1	1	0	1.4	4.8	13.3
8/5/17 6:30 PM	5.1	1	0.8	0	1.6	4.8	13.3
8/5/17 7:00 PM	4.2	1	0.8	0	1.2	5	12.2
8/5/17 7:30 PM	4.2	1	0.8	0	1.2	5.2	12.4
8/5/17 8:00 PM	3.8	1.2	0.8	0	1.2	5.6	12.6
8/5/17 8:30 PM	3.8	1.2	0.8	0	1.2	3.8	10.8
8/5/17 9:00 PM	4.9	0.1	0.8	0	1.2	3.8	10.8
8/5/17 9:30 PM	4.9	0.1	0.8	0	1.2	3.8	10.8
8/5/17 10:00 PM	5.1	1	0.8	0	1.2	3.8	11.9
8/5/17 10:30 PM	No data	No data	1	0	0.8	2	Inc. data
8/5/17 11:00 PM	No data	No data	1	0	0.8	2	Inc. data
8/5/17 11:30 PM	No data	No data	1	0	0.8	4	Inc. data
8/6/17 12:00 AM	No data	No data	1	0	0.8	8	Inc. data

A similar analysis was prepared by the project team for this report using logbook information for generated power. Computed power used by pumps was also determined based on horsepower and operating status (off, lite, loaded). A time-history of power used, power generated and maximum power available in the system is shown in Figure 30. Figure 31 shows the power used by pumps and the power necessary to supply pumps which were requested but denied along with a total power needed. The denied power was assumed to persist until the log book indicated the pump was started. The analysis indicates the required power exceeded the available power by more than 30%.

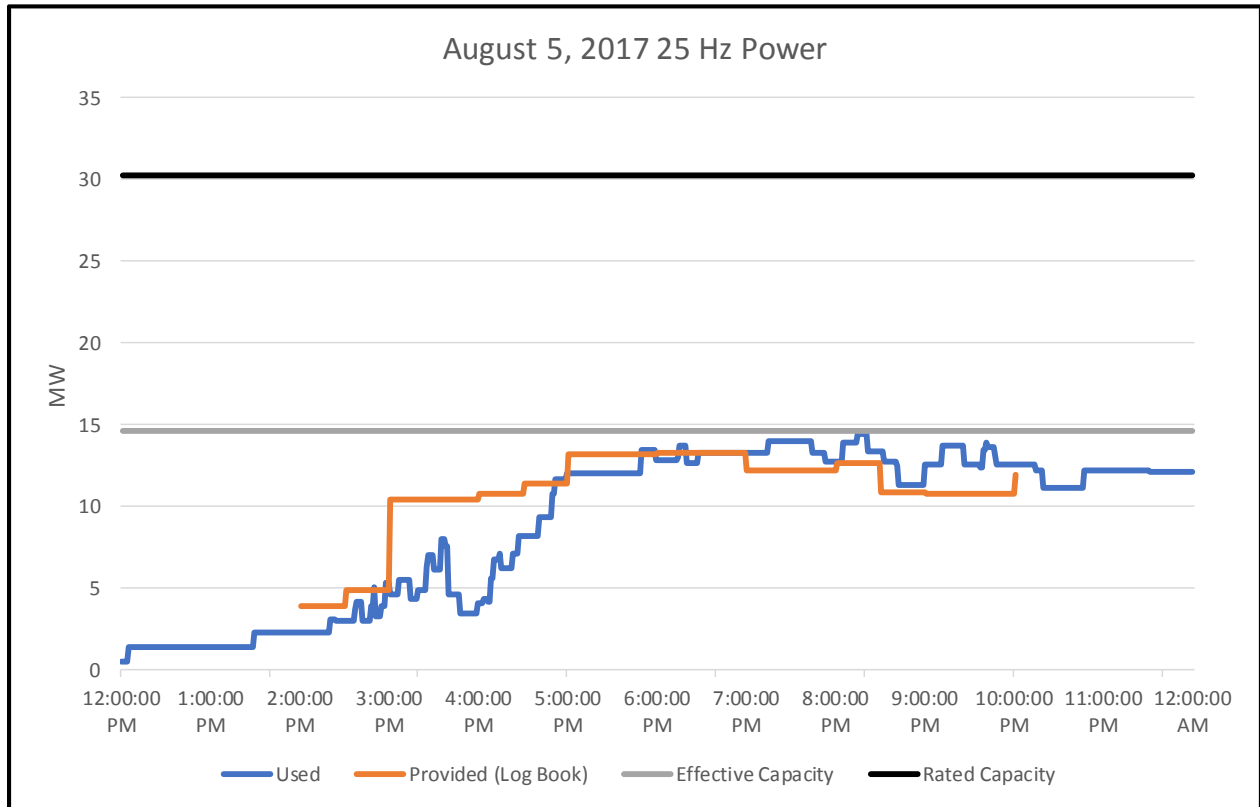

**Figure 30 25 Hz Power Used by Pumps and Power Capacity on August 5, 2017**

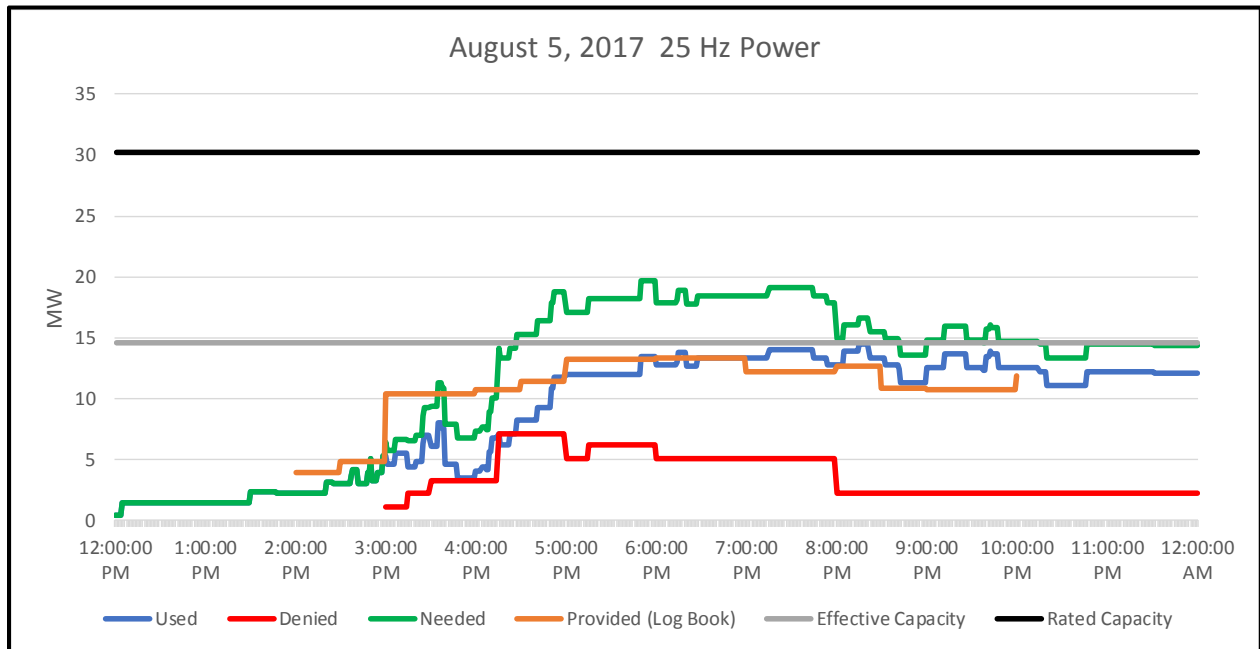

**Figure 31 25 Hz Power Demand vs Capacity**

**5.3.4. INTERNALLY GENERATED VS PURCHASED POWER**

Four separately interviewed former S&WB officials and board members stated their belief that the increase in the use of S&WB turbines leading up to the turbine failures in 2017 was in part motivated by the November 19, 2010 “catastrophic failure of all the redundant [power] systems” that required a two-day citywide water boil advisory.<sup>9</sup>

To assess evidence that S&WB made a policy change to use internally generated power to avoid Entergy power interruption, the power usage by S&WB drainage was evaluated and compared to power generated by the turbine generators. In Figure 32, the internal power production increased at a rate of 7-10% per year. Power purchase trends are shown in Figure 33. No clear trend is evident with regard to energy purchases. This data provides some indication of an increased reliance on internally produced power.

There is no evidence that S&WB leadership concurrently evaluated the impact of the increased use of these turbines on their overall functionality nor is there any evidence that provision was made for increased maintenance funding to minimize periods of power unreliability among these assets.

<sup>9</sup> [https://www.nola.com/opinions/index.ssf/2010/11/keeping\\_the\\_power\\_on\\_for\\_new\\_o.html](https://www.nola.com/opinions/index.ssf/2010/11/keeping_the_power_on_for_new_o.html)

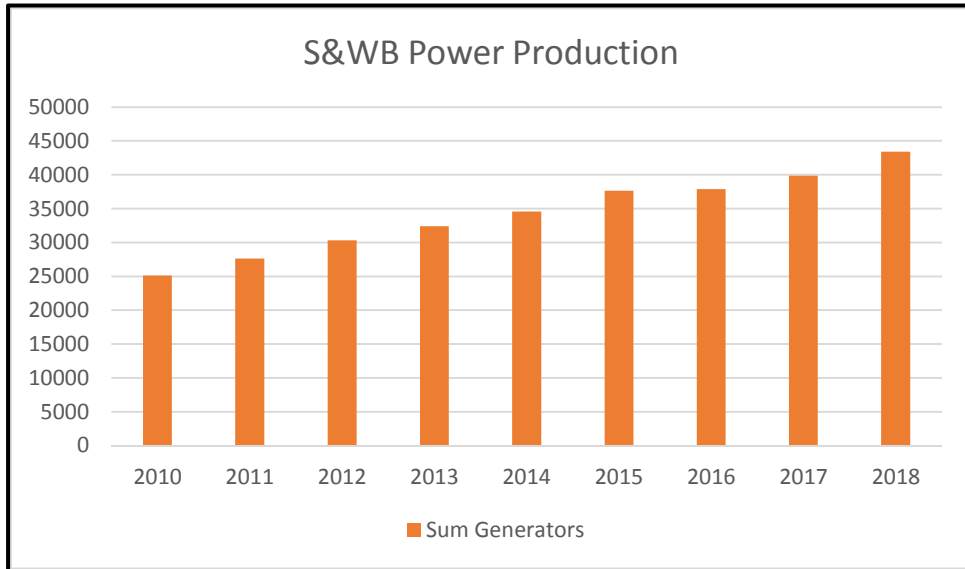

**Figure 32 Power Production by S&WB Turbine Generators(kWH)**

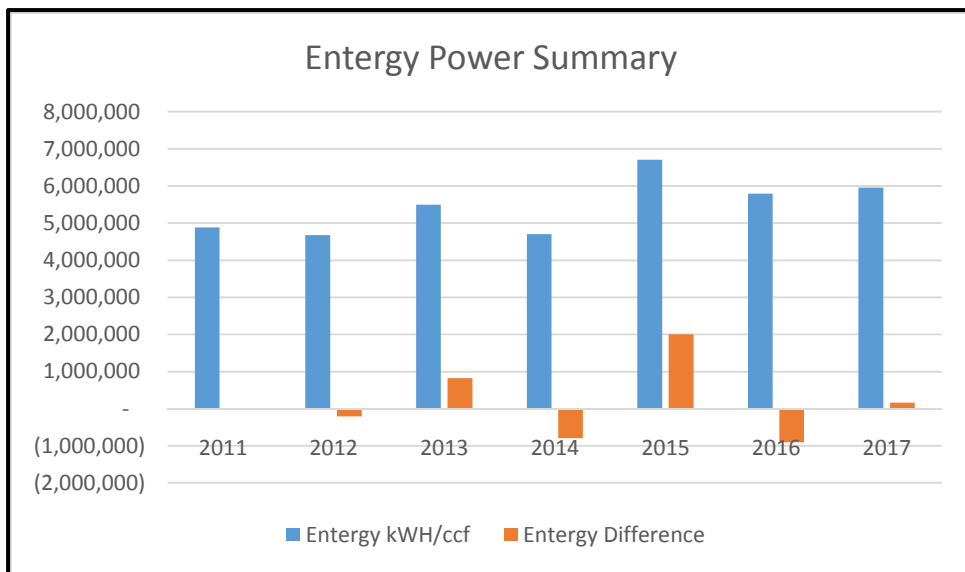

**Figure 33 Energy Power Usage by S&WB Drainage**

**5.4. S&WB PUMPING SYSTEM**

The S&WB pumping system was the focus of extensive scrutiny during the flooding in July and August. Conflicting information about availability of pumps and power has made it unclear if the system performed to its full capability. The assessment in this section evaluates the performance of individual drainage pumping stations on August 5, taking into account information collected from logbooks and interviews with personnel at pumping stations as well as analysis of pump flow and power availability.

**5.4.1. PUMPING SYSTEMS PERFORMANCE ANALYSIS**

Performance of the individual pumping stations in removing water from their respective drainage basins and their impact (if any) on adjacent drainage basins, was assessed by evaluating flood claims, suction basin levels, number of pumps available and used, pump run times and pump start denials. This analysis evaluated whether the system performed as designed and/or whether the level of performance was satisfactory.

An analysis was prepared, for each drainage pumping station, which compared the suction basin level to the pumping capacity used as a percentage of available pumping capacity. In cases where the available pumping capacity was less than the installed capacity due to inoperable pumps, the comparison with installed capacity is also shown. Figures are provided below for each drainage basin along with an evaluation of performance. An example comparison for DPS 7 is shown in Figure 34 and Figure 35. Even though up to 100% of the available pumping was used, it was only 60% of the installed capacity. These figures also show that substantial decrease in suction basin levels did not occur until all available pumps were running.

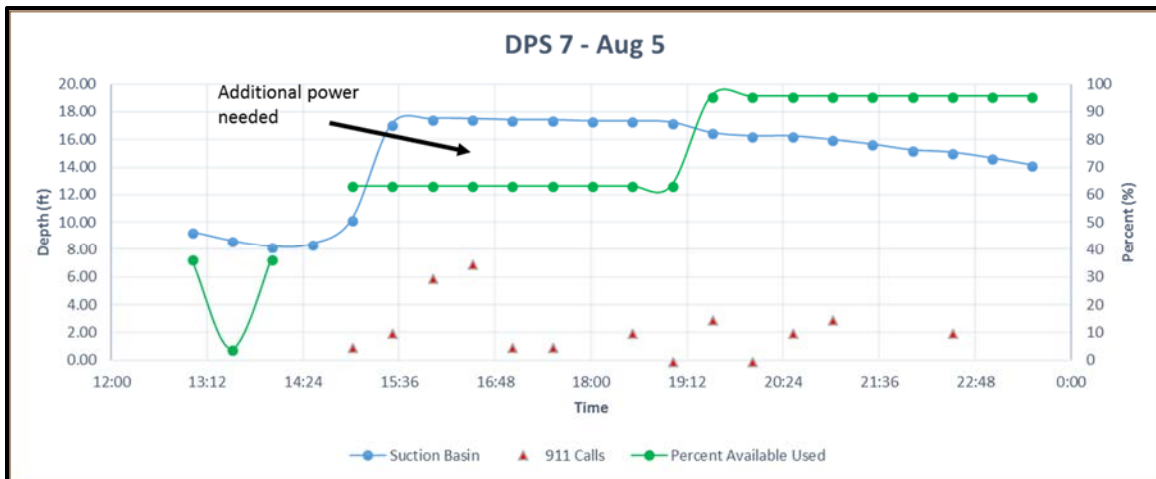

**Figure 34 DPS 7 Pumping - % of Operational Capacity**

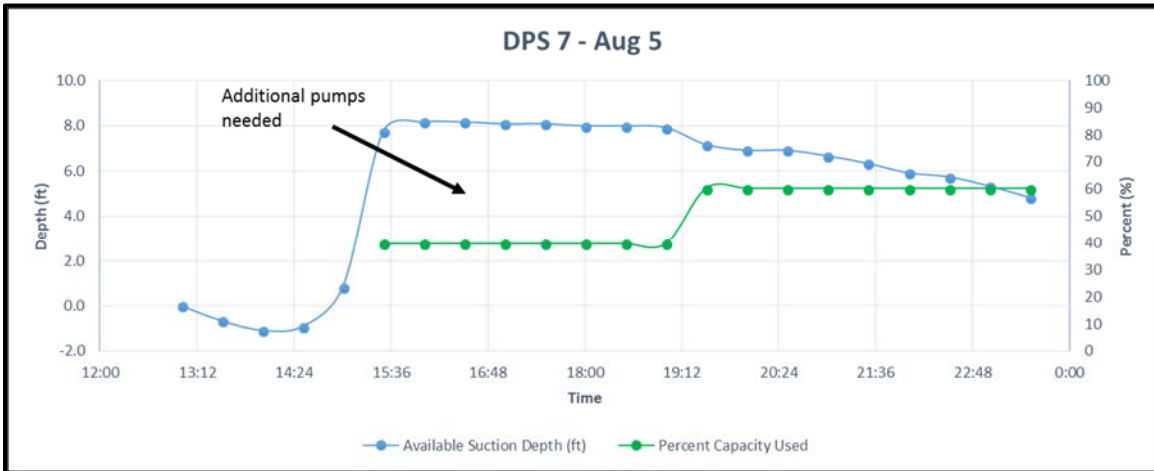

**Figure 35 DPS 7 Pumping - % of Installed Capacity**

Where pump start is delayed significantly, this is typically due to insufficient power to operate the pumps. Comparison plots for each pumping station for July 22 and August 5 is provided in Appendix F.1.

In most of the drainage basins on August 5, suction basins were cleared to pre-event levels and pumping was stopped after midnight. Suction levels then rose again as additional storm water flowed in from farther reaches of the drainage basins. The time to clear the suction basin after reloading was 2-9 hours depending on the drainage pumping station. A summary of the drainage pumping station performance for each drainage basin is provided below for the August 5, 2017 event. A description of drainage basin boundaries and average rainfall for each basin is shown in Figure 36 for reference.

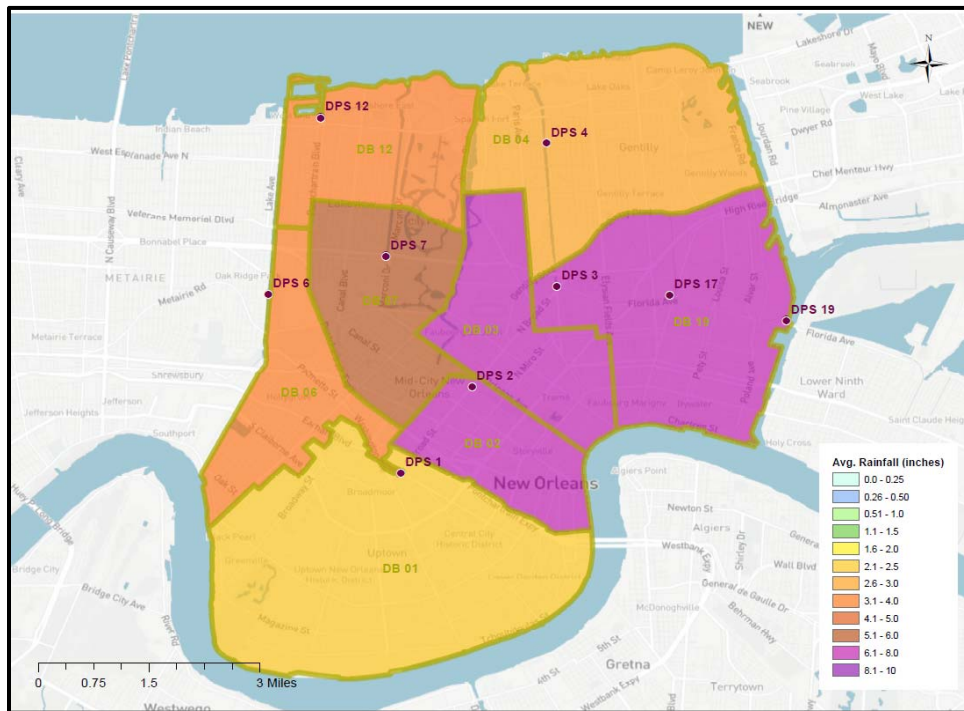

**Figure 36 Drainage Basin Boundaries and Average Rainfall**

**DPS 1**

This DB did not receive intense rainfall. Average rainfall of the drainage basin was 2.3 inches (<1-yr 6-hr event). The DPS substantially met target pumping capacity and did not experience significant flooding.

Pumping commenced at 2:55 PM and continued for approximately 15 hours in the initial period. The suction basin took approximately 16 hours to clear. Maximum pumping at the station used approximately 50% of the available capacity. Pumping started approximately 30 minutes after the suction basin began to rise and was able to keep pace with the suction basin level and shown in Figure 38. Power interruptions and loss of pump load were noted in the logbook.

**Conclusion.** The drainage basin experienced much less intense rainfall than other drainage basins. DPS1 exhibited capacity capable of providing an adequate LOS within its drainage basin during the event, with the result that there was little flooding in DB 1. Evaluation of the suction basin levels confirms that minimal flooding would be expected as shown in Figure 37.

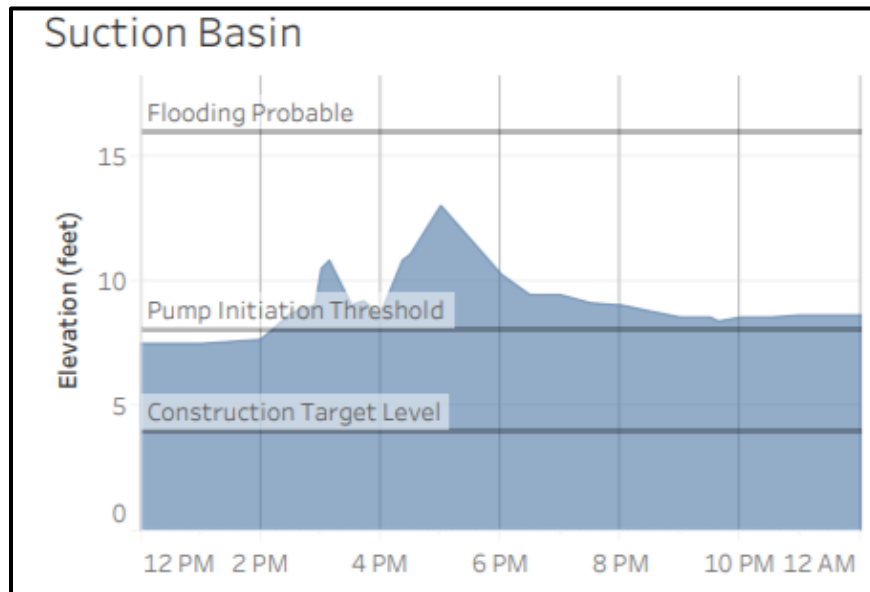

**Figure 37 DPS 1 Suction Basin Levels August 5**

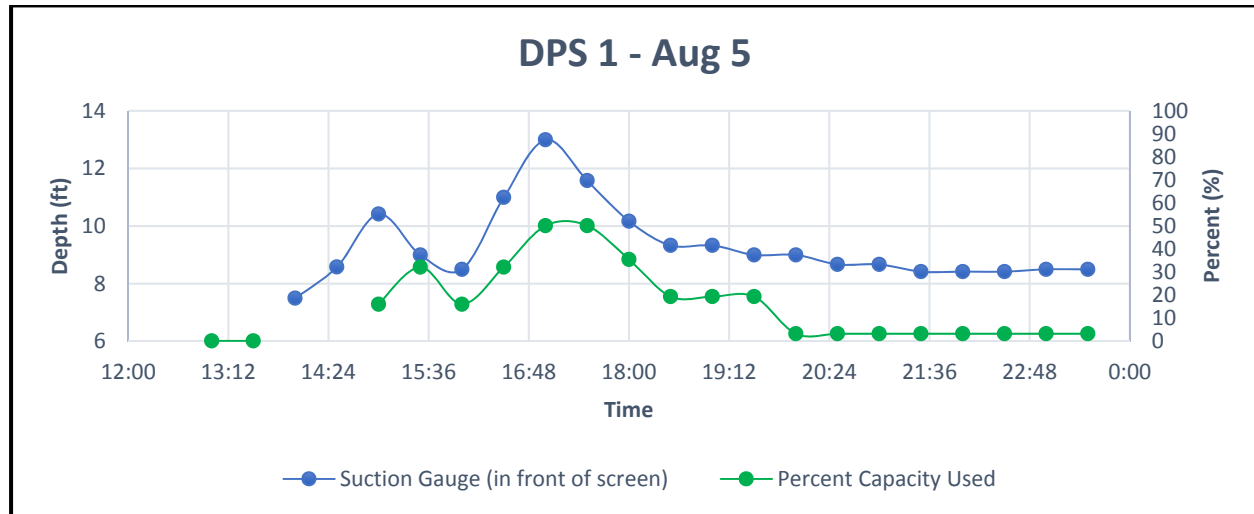

Figure 38 DPS 1 Pumping Performance August 5

**DPS 2**

Intense rainfall occurred with average rainfall of the drainage basin was 2.3 inches (>10-yr 6-hr event) and experienced significant flooding. The DPS substantially met target pumping capacity; however, DPS 2 target capacity is unrealistically low because this DB has a high proportion of impervious ground surface and small capacity drainage pipe. DPS 2 has highest degree of pumping redundancy of all Old City stations because St. Louis Ave. cannot handle operation of four drainage pumps. DPS 2 could not have had an additional 25-cycle pumps due to canal capacity limitations.

Pumping commenced at 2:30 PM and continued for approximately 9-1/2 hours in the initial period. The suction basin took approximately 9 hours to clear initially. Suction levels rose again after midnight until 11 AM. Pumping did not restart until 7 AM. Suction basin elevations were consistent with flooding in the drainage basin as shown in Figure 39.

Pumping started as the suction basin began to rise and kept pace with the suction basin level as shown in Figure 40. Maximum pumping at the station used approximately 70% of the available and installed capacity. Two requests to start pumps were denied at 3:11 and 4:00 PM. An additional request was denied at 7:48 AM on 8/6. Loss of pump load was noted in the logbook.

**Conclusion.** DPS2 functioned at current design during the event with few technical issues. However, there was significant flooding in DB 2. Despite the highest degree of pumping capacity redundancy in the S&WB drainage system, DPS 2 and system capacity is inadequate to handle intense rainfall events such as were experienced in most of DB 2 on August 5. Current pumping capacity in DPS 2 is limited by the capacity of the St. Louis Avenue Canal and possibly the Broad St. Canal. Capacity is also limited by the real-time functional capacity of outfall stations DPS 7 and DPS 3. While flooding would inevitably have occurred under such severe precipitation conditions, it is likely that flood depth and duration during the event could have been reduced if substantial improvement in DB 2 drainage pipe capacity occurred and DPS 2 discharge capacity was increased. It is also likely that flooding depth and duration would have been reduced if DPW drainage network cleaning, maintenance and repair had been accelerated.



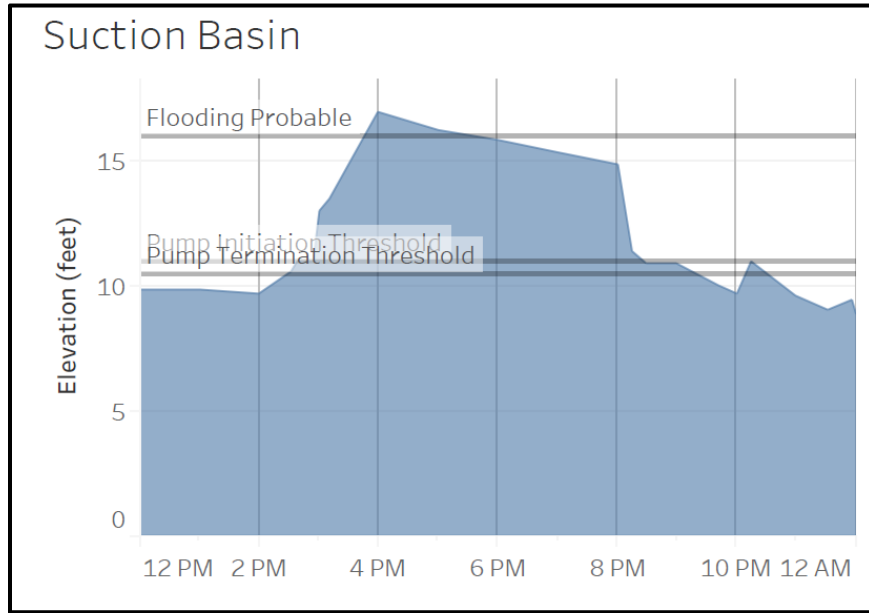

Figure 39 DPS 2 Suction Basin Levels August 5

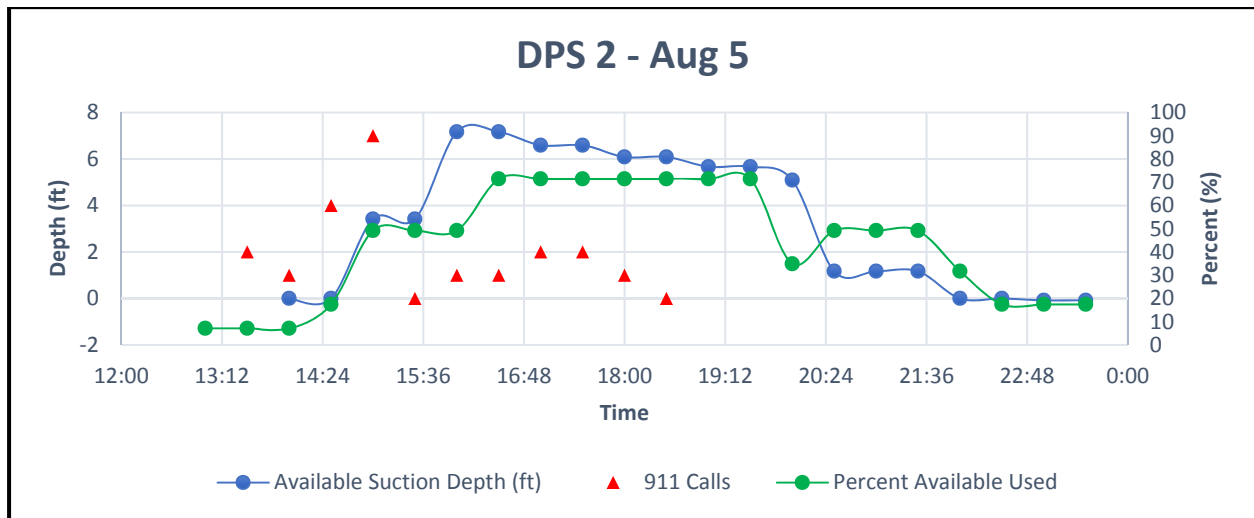

Figure 40 DPS 2 Pumping System Performance August 5

### DPS 3

This DB received intense rainfall averaging 7.8 inches (> 25-yr 6-hr event) and experienced significant flooding. Pumping commenced at 2:28 PM and continued for approximately 15 hours in the initial period. DPS 3 did not substantially meet pumping target until later in event due to power availability. DPS 3 could not lower its suction basin by midnight of August 5.

Maximum pumping at the station used approximately 50% of the available capacity for most of the initial pumping period rising to 70% after 8 hours. Pumping started well after the suction basin began to rise. Multiple requests to start pumps between 3:30 and 7:00 PM were denied due to power availability. Denied pumps represented approximately 23% of the operable capacity of the station. Pump starts request were also denied three times between 7:07 AM and 8:40 AM on August 6.

Pumping at 50% of available capacity kept pace with the suction basin level but was not able to lower the suction level until nearly 11 PM when additional pump was started as shown in Figure 42. After rising again on August 6, the basin was not cleared for approximately 12 hours. Suction basin elevations were consistent with flooding in the drainage basin as shown in Figure 41.

Multiple feeder voltage drops, and loss of pump load noted in the logbook. A pump ran backwards for an extended period.

**Conclusion.** Inability of DPS 3 to meet target pumping capacity through critical period of event was due to electrical issues (either system feeder supply problems or station feeder equipment issues). The electrical issues and difficulty in stopping pumps running in reverse quickly indicate that maintenance and repair were inadequate. While flooding would inevitably have occurred under such severe precipitation conditions, it is likely that flood depth and duration during the event could have been reduced if power supply to DPS 3 had been uninterrupted. It is also likely that flooding depth and duration would have been reduced if DPW drainage network cleaning, maintenance and repair had been accelerated.

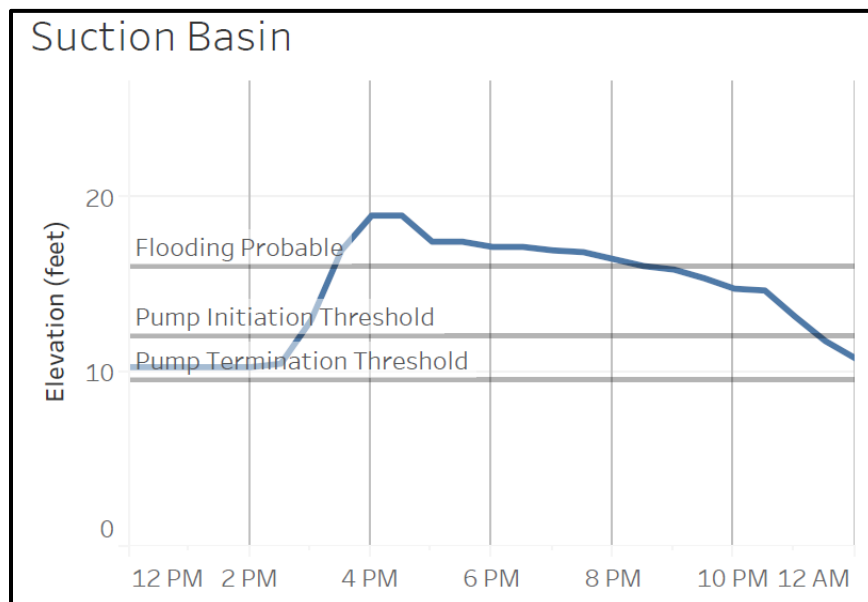

Figure 41 DPS 3 Suction Basin Levels August 5

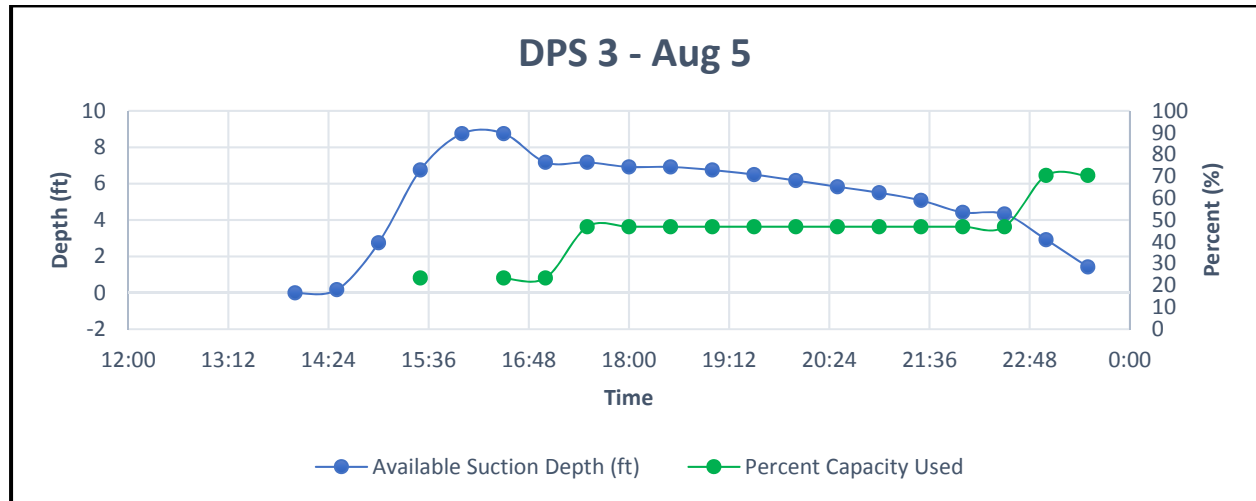

Figure 42 DPS 3 Pumping System Performance August 5

**DPS 4**

Average rainfall in DB 4 was 2.9 inches (>1-yr 6-hr event). Pumping commenced at 2:30 PM and continued for approximately 9-1/2 hours in the initial period but did not substantially meet target pumping capacity. Maximum pumping at the station used approximately 60% of the available capacity

Pumping started after the suction basin began to rise and was able to maintain the suction levels at the 60% rate as shown in Figure 44. Multiple requests to start pumps were denied between 4:20 and 4:30 PM. Capacity of the denied pumps represented approximately 27% of the installed capacity. Loss of pump load and feeder voltage drops were noted in the logbook.

The suction basin took approximately 15 hours to clear initially. Suction basin elevations were below levels expected to produce flooding in the drainage basin as shown in Figure 43. This suggests that the probable flood levels established for DPS 4 are not accurate.

**Conclusion.** Pump power request refusals prevented DPS 4 from attaining target pumping capacity throughout the event. It is likely that flooding during the event could have been reduced if sufficient power had been available to DPS 4 to operate an additional large drainage pump when requested.

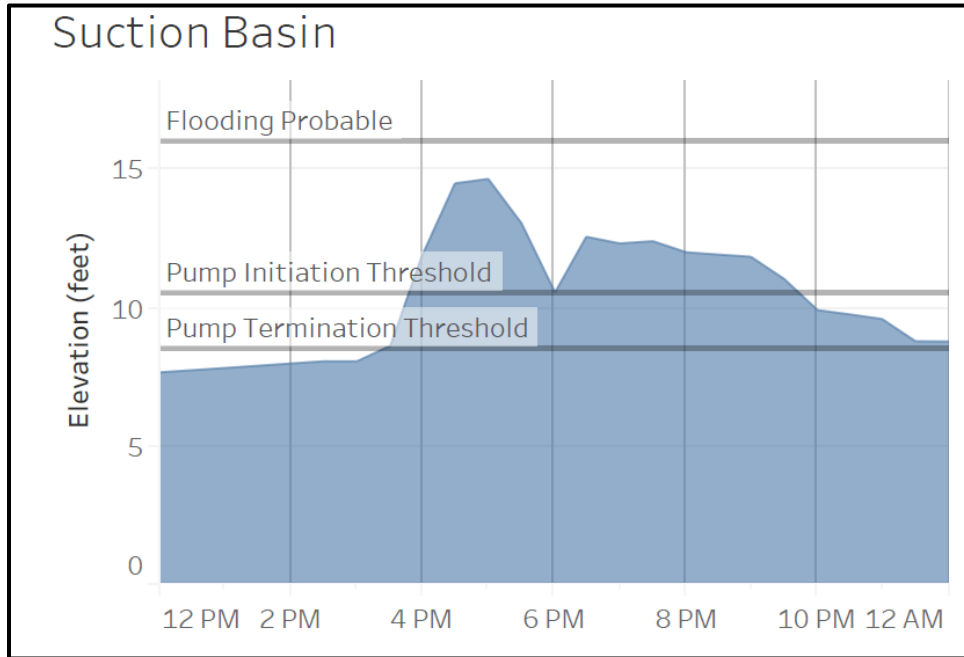

Figure 43 DPS 4 Suction Basin Levels August 5

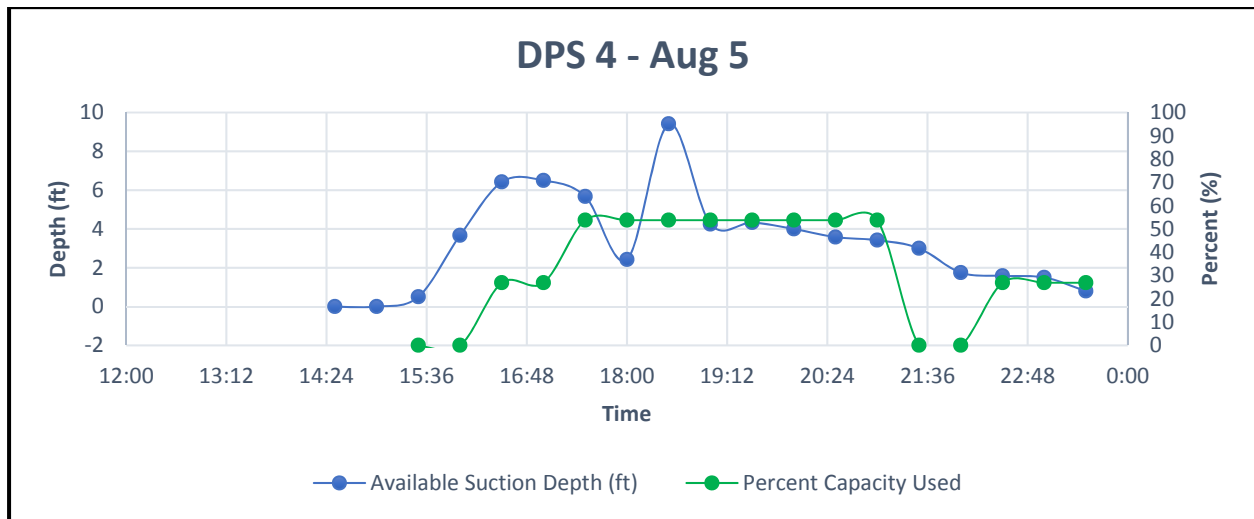

Figure 44 DPS 4 Pumping System Performance August 5

## DPS 6

DB 6 did not receive intense rainfall with the drainage basin experiencing an average rainfall of 3.2 inches (<1-yr 6-hr event). Suction basin elevations were consistent with flooding in the drainage basin as shown in Figure 45. DPS 6 target capacity is high due to requirement to discharge water drained from DB 1 and from 2500 acres in Jefferson parish. DPS 6 did not substantially meet the target pumping capacity even though all available pumps were run. Pumping commenced at 3:30 PM and continued for approximately 10-1/2 hours in the initial period. Pumping started well after the suction basin began to rise but did not keep pace until 90% of the available capacity was used. The suction basin took approximately 8 hours to clear initially and 10 hours to clear after rising on August 6 AM.

Maximum pumping at the station used approximately 90% of the available capacity but only 50% of installed capacity as shown in Figure 46 and Figure 47. Six pumps were out of service for a total not in service of 5300 cfs, half of station design capacity.

Multiple feeder voltage losses and pump load losses were noted in the logbook. A request for additional pump starts at 5:11 pm was denied. This request represented approximately 11% of the operable capacity. A decision was made to power the 25 Hz G Pump at DPS 6 rather than 25 Hz D Pump at DPS 12 for critical period of event.

**Conclusion.** DPS 6, even with reduced pump capacity, exhibited capacity capable of providing an adequate LOS within its drainage basin during the event, with the result that there was little flooding in DB 6. However, DB 6 experienced significantly less intense rainfall than other drainage basins. The decision to drain DB 12 for an extended period through DB 6, with the relatively limited drainage effect, rather than running D Pump at DPS 12, could have contributed to flooding depth and duration in DB 12. Had 25 Hz power been diverted from G Pump at DPS 6 to D Pump at DPS 12 at an earlier point in time, it is likely that flood depth and duration in DB 12 would have been reduced. If this had been done, there could simultaneously have been greater flood depth and duration in DB 6, although overall precipitation intensity was similar in both drainage basins. DB 12, as discussed below, was likely contending with run off from DB 7, which experienced significant flooding.

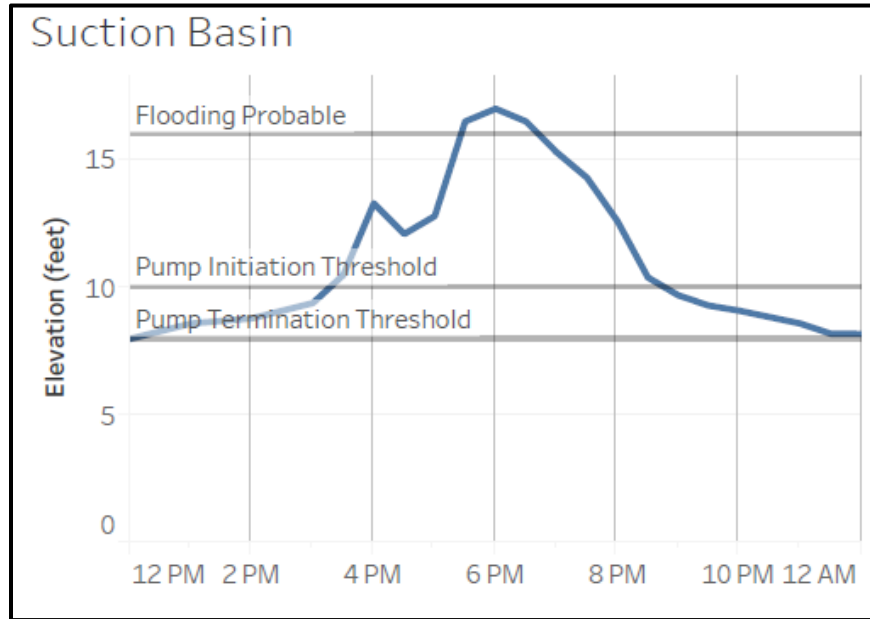

Figure 45 DPS 6 Suction Basin Levels August 5

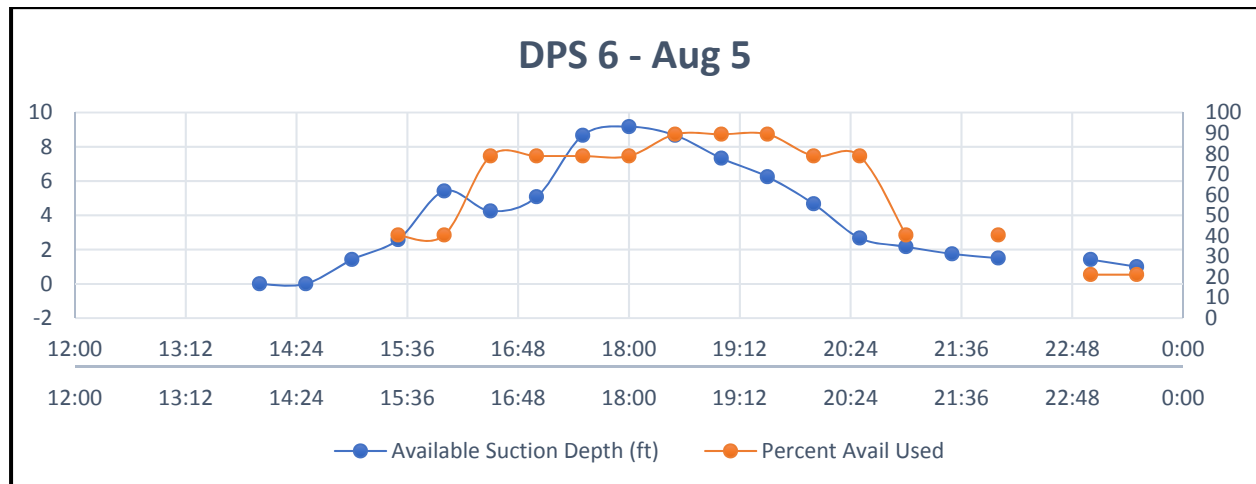
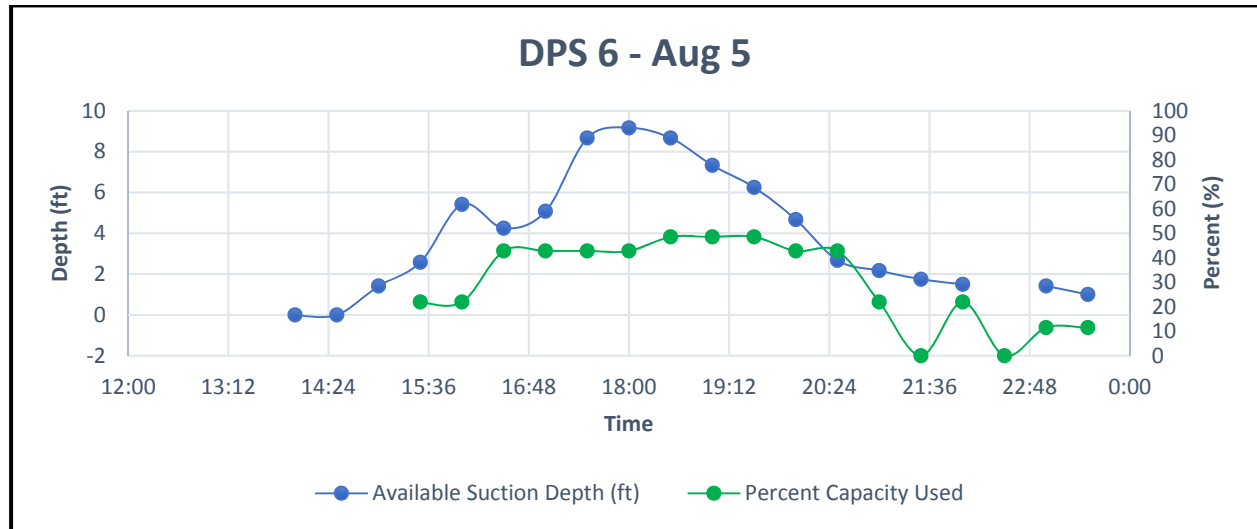

Figure 46 DPS 6 Pumping System Performance August 5 – Available



**Figure 47 DPS 6 Pumping System Performance August 5 – Installed Capacity**

**DPS 7**

DB 7 received intense rainfall with an average rainfall of 5.6 inches (>5-yr 6-hr event). Pumping started at 1:30 PM as soon as the suction basin began to rise but was not able to reduce the suction level until additional pumps were started at 7:00 PM when it began a slow decrease in levels. Additional available pumps (with adequate power supply) would have limited the suction basin level rise and reduced it more quickly.

DPS 7 did not substantially meet target pumping capacity, with three large drainage pumps not in service and experienced significant flooding. Maximum pumping at the station used approximately 100% of the available capacity but only 60% of installed capacity as shown in Figure 49 and Figure 50. Three requests for pump start between 3:00-3:30 pm were denied and pump load loss was noted in the logbook.

Suction basin elevations were consistent with flooding in the drainage basin as shown in Figure 48.

**Conclusion.** DPS 7 has among the lowest pumping capacity redundancy of any drainage pumping station surpassing only the single-pump DPS 12. Together, these two stations drain approximately 5,340 acres with 145% of target drainage pumping capacity, lower than any other basins. On August 5, capacity of DPS 7 was significantly reduced such that at midnight the suction basin remained significantly elevated above pre-event level. Pumping capacity was clearly inadequate in that DPS 7 not only did not meet its target pumping capacity, but it was incapable of doing so. It is likely that significant runoff from DB 7 flowed into DB 12, which although it did not receive relatively intense rainfall, experienced significant flooding. C Pump at DPS 7 had been out of service since March 2016 and this failure of maintenance and repair management left not only DB 7 at risk for unnecessary flood impacts, but increased risk in DB 12 as well. It is also likely that flooding depth and duration would have been reduced if DPW drainage network cleaning, maintenance and repair had been accelerated.

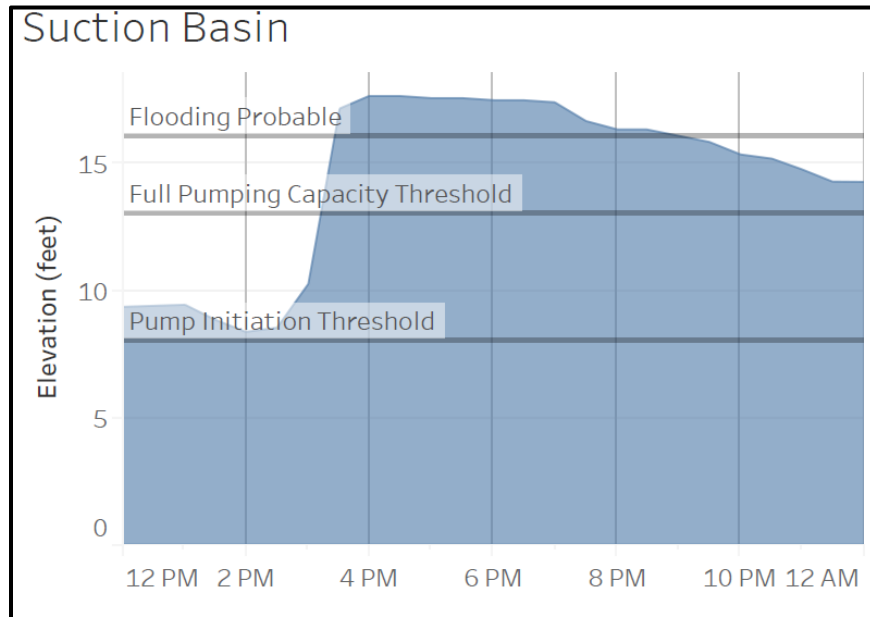

Figure 48 DPS 7 Suction Basin Levels August 5

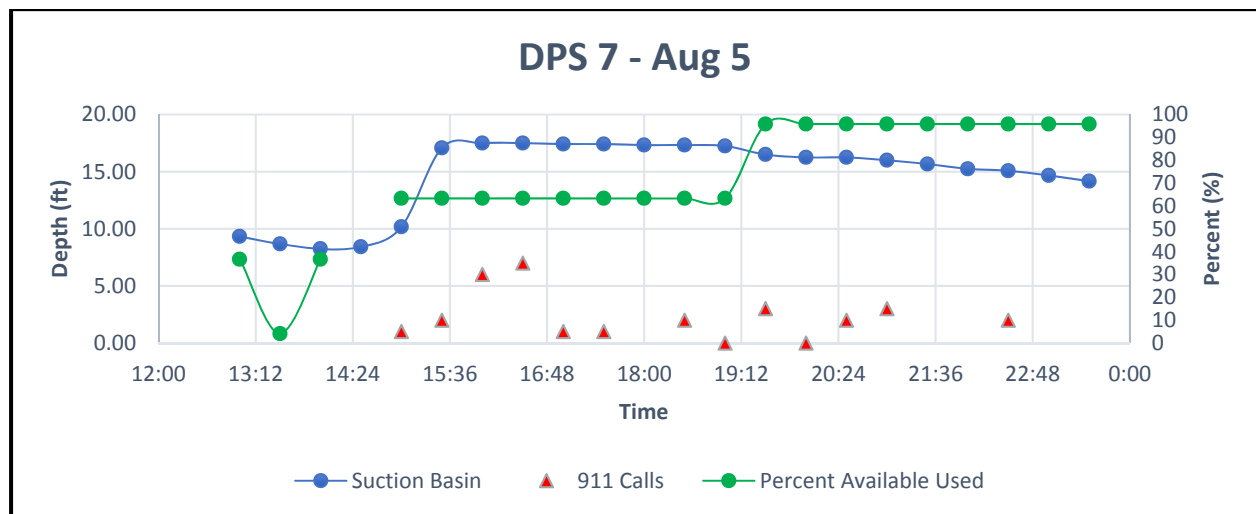

Figure 49 DPS 7 Pumping System Performance August 5 - Available



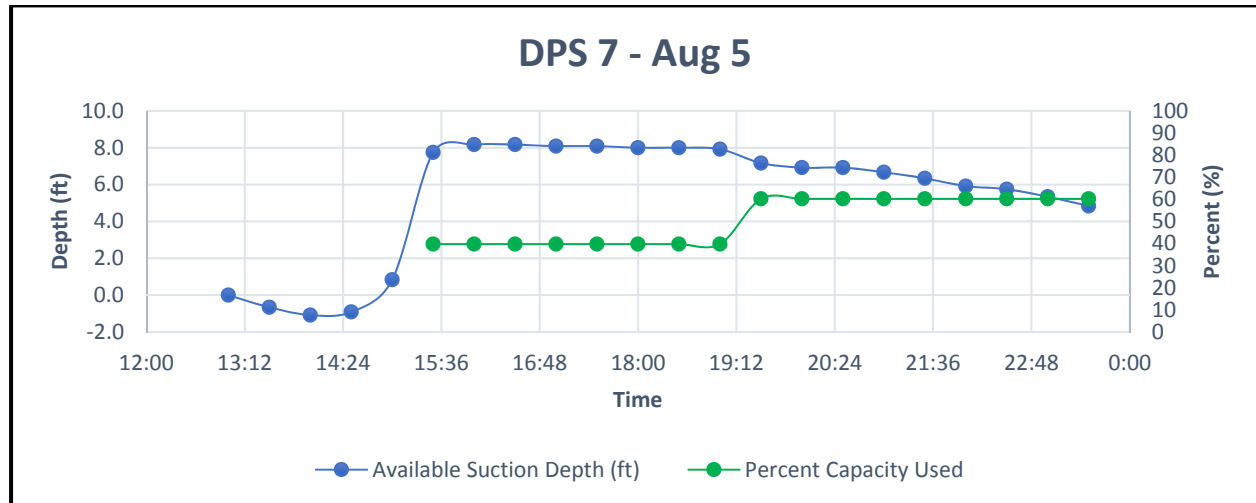

Figure 50 DPS 7 Pumping System Performance August 5 - Capacity

**DPS 12**

DB 12 did not receive intense rainfall averaging 3.4 inches over the basin (<1-yr 6-hr event) but did experience flooding. A high suction basin level alarm occurred at 3:41 PM on August 5 and 9:41 AM on August 6.

DPS 12 did not meet target pumping capacity. The single pump at DPS 12 was started late due to lack of available power and met pumping target only later in event. A request for pump start was denied at 7:55 PM. Pumping commenced at 8:49 PM and continued for approximately 4 hours. Pumping was stopped because the pump would not hold load. A restart was attempted at 2:30 AM but was not successful. Operators left the station.

Maximum pumping at the station used 100% of the available capacity (Figure 52) with suction levels dropping approximately 2 hours after pumping was started. The suction basin took approximately 7 hours to clear. Suction basin elevations were not consistent with flooding in the drainage basin as shown in Figure 51.

**Conclusion.** Undoubtedly flood depth and duration in DB 12 would have been reduced had DPS 12 become operational at an earlier point in the event. As has been discussed previously, because 60 Hz I pump at DPS 6 was not in service, an operational decision was made to power 25 Hz G Pump at DPS 6 rather than 25 Hz D Pump at DPS 12, for a critical period of the event. DB 12 likely had runoff impact from DB 7, but there was also likely a miscalculation as to the drainage impact of DPS 6 within DB 12. In the event, DB 12 experienced significant flooding and DB 6 experienced less flooding.

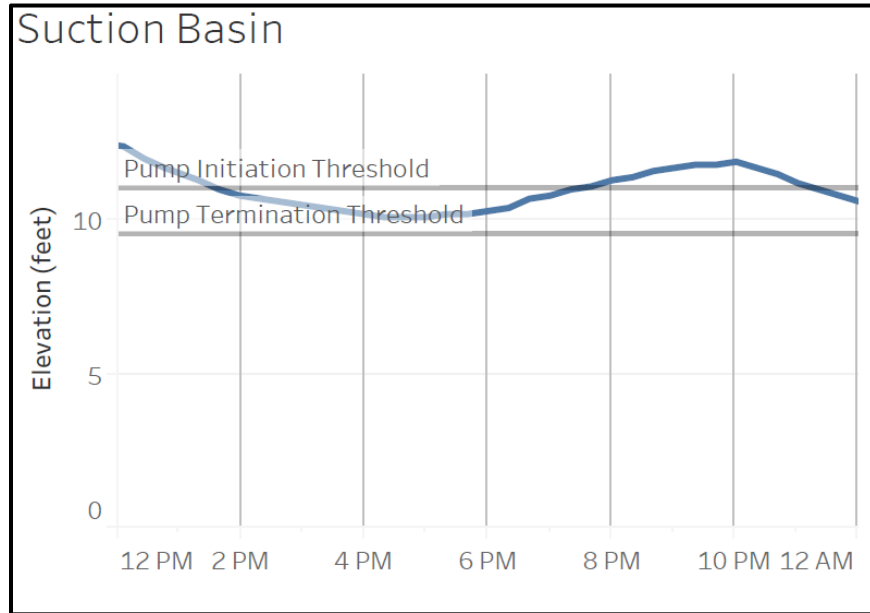

Figure 51 DPS 12 Suction Basin Levels August 5

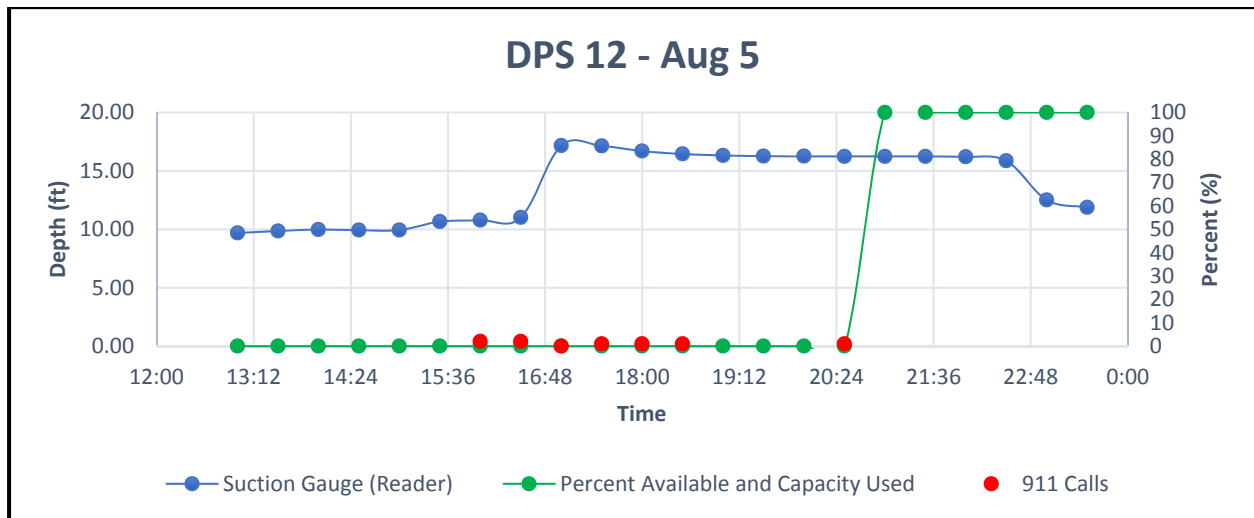
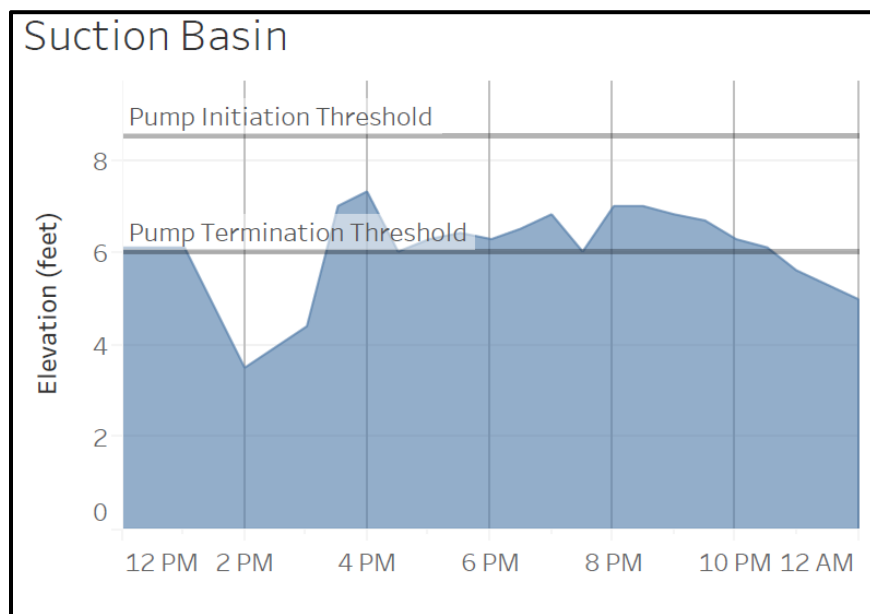

Figure 52 DPS 12 Pumping System Performance August 5

**DPS 17 and DPS 19**

DB 19 experienced intense rainfall. Average rainfall over the drainage basin was 6.0 inches (>10-yr 6-hr event). Pumping commenced at 4:30 PM and continued for approximately 14 hours in the initial period. Maximum pumping at the station used approximately 20% of the available capacity for most of the pumping period rising to 40% for a brief time as shown in Figure 53 and Figure 54. DPS 19 did substantially meet target pumping capacity; however, significant flooding occurred.

**Conclusion.** DPS 19 largely functioned at current design capacity during the event with few technical issues. The station is entirely 60 Hz and had no power supply issues. However, there was significant flooding in DB 19. Despite a moderate level of pumping redundancy, DPS 17 and 19 and system capacity is inadequate to handle intense rainfall events such as were experienced in most of the drainage basin. While flooding would inevitably have occurred under such severe precipitation conditions, it is likely that flood depth and duration during the event could have been reduced had the Florida Avenue Canal Enlargement SELA project been completed and most probably also reduced if DPS 17 and DPS 19 discharge capacities were increased. Flooding would also likely have been reduced if DPW drainage network cleaning, maintenance and repair had been accelerated.



**Figure 53 DPS 19 Suction Basin Levels August 5**

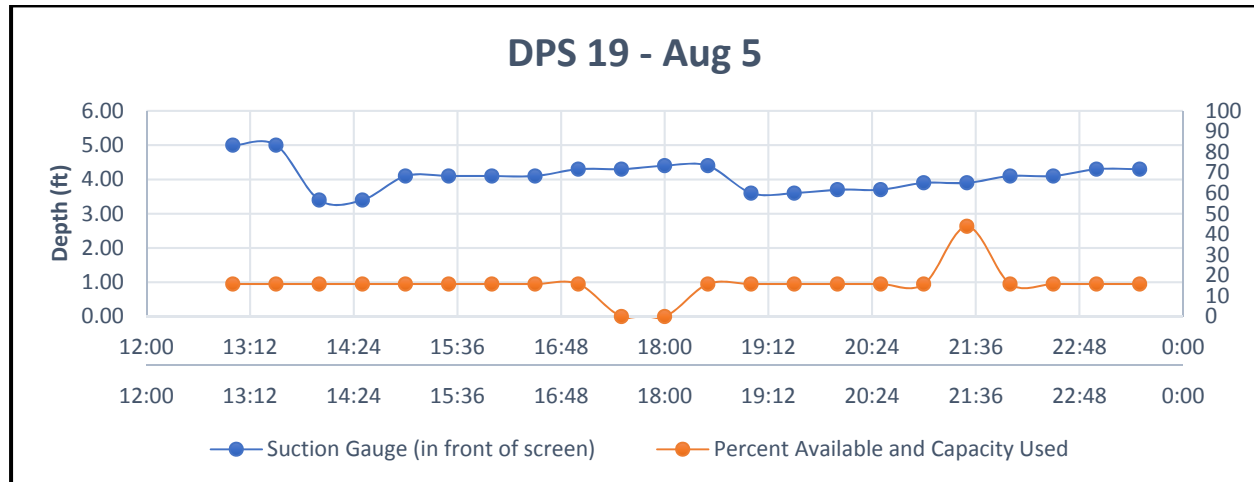

Figure 54 DPS 19 Pumping System Performance August 5

**5.4.2. PUMPING SYSTEMS MAINTENANCE**

A good maintenance program is critical to ensuring the smooth operation and high availability of machinery for operation. Programs typically fall into two categories: reactive maintenance (RM) and preventative maintenance (PM). In a reactive maintenance program, machinery is operated until a failure occurs. The faulty component is repaired or replaced, and the machinery is brought back into service. This minimizes downtime for continuously operating machinery and may have a lower short-term cost for minor repairs on simple and inexpensive equipment with few moving parts. Preventative maintenance programs are intended to reduce wear, replace parts prior to failure and reduce the frequency unplanned service interruptions. This type of program is especially important for expensive hard to replace equipment. These programs tend to have predictable costs proportional to design life and quantity of consumables (lubricants, fuses, gaskets, washers, etc.) required. Both types of programs require redundant machinery (extra capacity) to ensure the required service level is met when equipment is out of service for either reactive or preventative maintenance.

S&WB Drainage Department has a hybrid program that has both reactive and preventative elements where the responsibility is shared by outside departments to execute effectively, i.e. the workshops, contractors and engineering. Drainage relies on electronic requests for maintenance from operation’s and power’s supervisors and printed (or hand written) shop tickets for electrical system’s preventative maintenance. The electronic system is referred to as CASSworks. The shops use the system to print out shop tickets for electrical PM items. Requests for maintenance by operators are vetted through their supervisors prior to entry into the system. Therefore, a large number of equipment minor defects could be known to operators but are not documented for engineering or management to act upon until a critical failure occurs. No trending of long term insipient problems can be performed in such a system.

Operator interviews indicated that an informal preventative pump maintenance program has been implemented however, many larger items are deferred and result in reactive maintenance jobs. The Operators and UPW indicated they perform preventive maintenance work routinely on a schedule, but no preventative maintenance schedule was provided to the project team on request for documentation. There is a preventive maintenance program for the sewerage operations developed as part of the consent decree, but it is not directly applicable to drainage operations and is general in nature.

Maintenance work may be recorded in the log books but would not be in the CASSworks system. The pump logs contain some preventive maintenance information since operators are supposed to log work that is performed in a concise short format. The historical logs are kept at each station and interviews indicated that outside contractors have had to come to each station in order to review them for maintenance and outage history. This indicates no central copy of the logs are maintained by management and engineering.

The PM work drainage operations routinely perform are checking oil, greasing bearings, replacing fuses, checking voltages and currents and dusting motor windings. They perform operational tests on valves, switches and all pumps for, but not while under load. Therefore, the value of the tests is limited to the specific component being tested and would not always reflect the full systems readiness under full load or a longer duration of use. When a defect is detected by operations the operator notifies his supervisor who then reviews the problem and attempts to resolve the issue. If the issue cannot be resolved in the field, the supervisors enter a work order into the CASSworks system. The supervisor is responsible for assigning a priority to the ticket where the responsible department then prioritizes work based on the priority ranking assigned and issues shop tickets to staff to effect more detailed troubleshooting and field repairs. Operators indicated the request for repairs are typically acted upon within 24 hours and often less than 12 hours for critical items. If the job cannot be completed in-house or the cost is high, then the job would enter the project management system for repairs which can take months to work through the approval process. Operators gave no indication that the criteria for a fault was more than functional or non-functional. Therefore, a component which was operational but not performing adequately (e.g. vacuum pumps for priming or drainage pumps loading) may be not be noted as defective in the maintenance system.

The pump system requires significant electronic infrastructure to operate and power. Electrical PM jobs are handled entirely by the electrical shop. Feeders, transformers, breakers, bus ties, switches, generators, all associated power and control circuits are serviced by the electrical shop or contractors. The CASSworks system maintains the list of PM work orders and they must be manually printed out by a shop supervisor to hand out to personnel for the entire S&WB. The list of and priority of these tasks were not provided to the project team. They could reasonably be deferred if higher priority work is needed. If there is a shortage of skilled labor to perform the work a backlog of work will result. In the event that labor shortages become chronic (hiring delays and retirements) or long delays in project approval then many PM jobs would become reactive maintenance and would be performed during rain loads and under emergency conditions.

The larger ticket items (costing more than \$30,000), which are referred to the Engineering Department for action, are prioritized at an annual meeting of supervisors and directors where they review funding, project cost and necessity of repairs. This list was not provided to the project team. The S&WB uses the list to create the budget requests for the capital projects budget in the following year(s). The S&WB staff do not appear to ask for more funding than is expected in the budget therefore any projects which do not make the priority list are deferred until the next budget cycle or deferred indefinitely.

During a rain load the normal process of using the CASSworks system is somewhat circumvented. If a defect occurs during operation, central control and supervisors are notified by operations. If the equipment failure is deemed critical then the shop which would be responsible for repairs is called, and the next available worker is sent out to effect repair. The expectation is that the appropriate work order

will be made in CASSworks by supervisors while work is being done or after the rain load is cleared. Interviews with staff which maintain the CASSworks system indicated significantly fewer CASSworks tickets exist than would be expected for the drainage department given size and complexity of the systems involved.

A significant dichotomy in culture, as regards to maintenance, exists between the frontline operators and upper level managers. A “make do” culture was in evidence from a top down mandate (interviews with senior managers) but was not reflected in interviews with front line operators. Front line personnel see a system responsive to them through the shop workers, welders, electricians, contractors and supervisors arriving to get equipment back online. Interviews with most operators indicted they felt that maintenance was promptly performed, and the equipment problems were largely resolved. The notable exceptions of significant equipment left out of service for long periods of time brings this into question. Management, above supervisor’s level, largely see the system as making do with what they have. Once a piece of equipment does not work, then it is no longer available, and staff find a way to make the situation work. Although this follows the reality of the situation in real time, the culture discourages problems from being brought up after the fact to be addressed. The risk to the S&WB is that repairs are assigned to get the equipment running, but not necessarily back to manufacturer specifications, or back to long term reliability. In the short term the equipment may not ever be repaired as operators do not repeatedly notify supervisors equipment is out of service. They notify each other of the current status daily at shift changes, but once defective equipment has been entered into a CASSworks ticket the responsibility shifts to another department.

There are quite a few examples highlighted in reports and presentations by CH2M, Veolia and other contractors of equipment items which are known to be partially or wholly defective at the S&WB. A few particular cases suggest more insipient problems exist within the S&WB due to low prioritization of preventative refurbishment over reactive repairs.

The C Pump bearing failure at DPS07 is one item worth noting because it is not unique to one DPS or even the Drainage Department. The inboard motor bearing failure resulted in damage to the motor when it failed. The pump has been long out of service since March 11, 2016. Interview with operations indicated a problem with the bearing was known to operators prior to failure, but a timely repair was not made. The interviewee stated at some point the issue was exacerbated by further operation, which resulted in operational loss of C pump. The station is nominally understaffed and relies on rotating overtime through operators, relief operators and supervisors to keep the station manned. The bearing could have been replaced when issues were noted by operators but was deferred until failure ultimately occurred. Interestingly CH2M noted the failure was likely due to a lack of lubrication which is an operational PM. The lack of consistent detailed maintenance records makes this difficult to prove. Bearings are a major wear component in mechanical systems. The failure of a single bearing can damage other equipment components: impellers, pump shafts and motor windings. The larger components are more time consuming and costly to repair. The resulting equipment Loss Event was not unique to one drainage station and occurred in no less than seven recorded instances prior to August 5, see Table 23.

**Table 23 Long Term Equipment Failures unaddressed by Aug. 5**

Station	Date	Pump Name	Failure Cause(s)
DPS01	8/29/2005	CD1	Bearing Repair Needed
DPS06	4/28/2011	CD2	Bearing Failure, Locked Motor
DPS20 AMID	8/21/2013	No.1	Bearing Failure, Damaged Impeller
DPS11	3/5/2015	D	Motor Failure
DPS11	9/5/2015	B	Lubrication Pump inoperable due to electrical failure, bearing needs maintenance
DPS06	10/27/2015	I	Bearing Failure, Damaged Impellor
DPS07	3/11/2016	C	Bearing Failure, motor failure
DPS05	10/14/2016	2L	Bearing Failure, Damaged Shaft
DPS06	11/18/2016	C	Motor Failure
DPS01	6/8/2016	V2	Bearing Failure, Damaged Shaft
DPS05	10/14/2016	2R	Packing sleeve Failure, Damage to Impellor and shaft
DPS06	6/21/2017	F	Motor Failure
DPS06	6/7/2017	D	Motor Failure

The brake system for all drainage pumps at S&WB have been taken out of service due to an asbestos exposure concern to workers. The brake system was redundant to the vacuum breakers, intended to stop the pump shaft from reversing direction in the event of intentional or unintentional power loss to the pump. Although not capable of stopping a pump from turning while power is provided (or once rotating backwards) the system had the benefit of preventing the reverse flow if engaged immediately on loss of power. A typical maintenance response could have been to substitute components in kind which contained no or less asbestos. Interim mitigations options include asbestos air quality monitoring, periodic medical evaluations and appropriate personal protective equipment (PPE) until replacement can be made. The choice to completely mothball a failsafe system is unusual although the reason given, to protect workers, is a worthy end goal.

The maintenance program at the S&WB needs significant improvement. Although lack of funding is often cited for the cause of deferred maintenance, some items cannot be deferred without significantly increasing repair costs due to damage to other connected components. The unification of all departments into one work order system with one database would greatly aid in both execution of work, trending of long-term chronic issues, addressing delays and estimates of scope for work for contractors. The current system can be used as such or another system could be procured. The emphasis must be placed on the uniform and consistent use of the work order system for preventive and reactive maintenance items. Once information is available departments need to flag repeated repairs, flag excessively high cost repairs, trend expenses and trend repair frequencies. Maintenance programs can use the information to provide detailed feedback to operations to reduce operational errors, perform detailed root cause analysis to reduce repeated mistakes and inform leadership about the necessary funds required to maintain reliability of the drainage system in the future.

### **5.5. HYDROLOGIC ASSESSMENT**

Hydraulic models were collected in an attempt to understand the hydraulics and hydrology of the surface flooding during the storm events. The models were expected to assist in providing information such as the amount of flooding within the city, the locations of the flooding and where the surface water flowed during and after the storm events. The models could also provide comparisons of the situation such as flooding based on the catch basins being clogged or open, or flooding based on all the pumps running to only the pumps that actually ran during the events.

CH2M and Ardurra provided hydraulic models for our investigation. CH2M provided a HEC-RAS hydrologic model that was developed after the August 5, 2017 event. Unfortunately, this model was not complete and still needed work in order for it to be properly analyzed. CH2M stated that during production of the model, the City of New Orleans and the S&WB directed CH2M to discontinue work leaving the model incomplete.

Ardurra provided seven PCSWMM hydraulic models. Each model was calibrated to the conditions of the August 5, 2017 event. These conditions include matching water surface levels that were recorded within the system and only including the pumps that were operational during the event. However, during detailed discussion with Ardurra, it was determined that the calibration was based only on suction basin and discharge elevations and was not calibrated to gauges distributed through the drainage basins. The data on these gauges was missing or unreliable. Also, the drainage basins were spilt up into multiple models rather than in one model, so the results would not take into account the other basins not in that model. Due to these reasons, our investigative team could not use these models in the analysis to attribute flooding between DPW and S&WB systems.

CDM Smith provided studies of system flooding by drainage basin for various storm recurrence intervals. These were evaluated to see water depths that would be predicted for a fully functioning, unobstructed system for storm frequencies which were observed on August 5. In drainage basin 3, where significant flooding was observed, rainfall with storm frequency equivalents between 10 and 100 years. Plots from the CDM Smith report for these frequencies are shown in these compare favorably with observed depths from the NOHSEP damage assessment shown in Figure 55 and Figure 56.



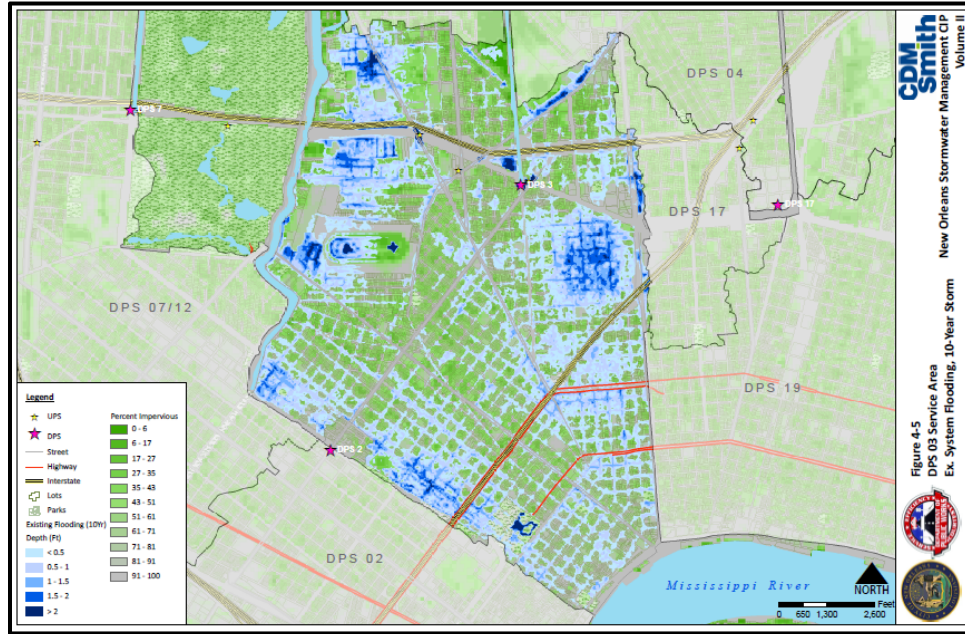

Figure 55 Predicted Flooding in DB 3 for 10-Year Storm

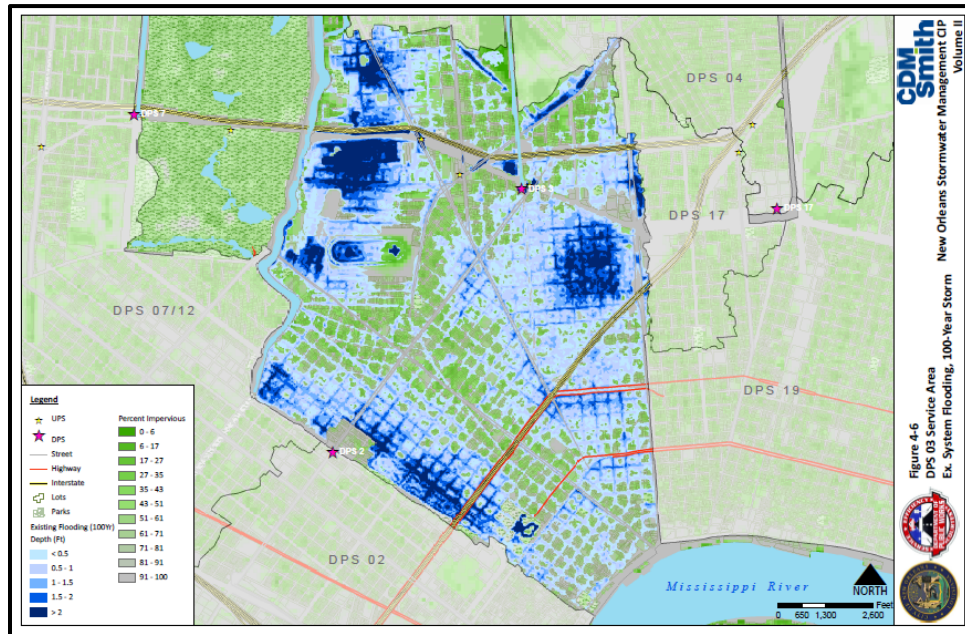

Figure 56 Predicted Flooding in DB 3 for 100-Year Storm

## **5.6. S&WB DRAINAGE SYSTEM FINANCIALS**

The causal factors of the Loss Events relating to underperforming S&WB drainage related assets and operations have roots in structural funding challenges and oversight inefficiencies that will worsen over time if unaddressed. Indeed, a lack of sustainable, sufficient funding was among the most commonly cited reasons for turbine and pump related problems during interviews with current and former Board of Directors, senior S&WB officials and department personnel. These interview testimonials paired with an analysis of S&WB drainage budgeting and expenses reveal four specific elements evidencing how S&WB's pervasive drainage funding challenges was a root cause of many of the causal factors giving rise to the Loss Events:

1. Currently available funding sources for S&WB drainage capital investment and operations is not sufficient to meet existing obligations, while also addressing unmet maintenance needs, priority capital asset repairs and upcoming final obligations.
2. The December 2016 expiration of one of S&WB's three *ad valorem* tax sources without certainty as to its renewal by the Orleans Parish electorate was a factor compelling S&WB management and Board of Directors to restrict drainage related maintenance and capital expenditures in 2015 and 2016 to build a reserve for the possibility of Insufficient future funding.
3. S&WB drainage related budgeting process lacks real-time analysis and probing oversight of changing operational and capital investment needs during the fiscal year involving the Board of Directors and New Orleans City Council.
4. Hesitancy to pursue enactment of a drainage service fee to supplement or supplant current tenuous funding sources has delayed any options for pursuing additional bond financing for major turbine and pump asset related improvements.

### **5.6.1. INSUFFICIENT AVAILABLE FUNDING SOURCES FOR S&WB DRAINAGE CAPITAL INVESTMENT & OPERATIONS**

Repeatedly, in every interview of current and former S&WB board, management and other personnel focused on the reasons for offline or underperforming electrical and pumping assets; the above illustrated annual lack of sufficient funds for maintenance and capital improvements was stated as the leading root cause.

In the years leading up to the Loss Events, S&WB was increasingly unable to fully invest in the necessities of its drainage operations, including operations, deferred maintenance and capital asset repairs and improvements. This chronic funding challenge is one of the root causes of the electrical system and pump asset failings, which were among the causal factors of the Loss Events. Of equal importance, S&WB's own analysis indicates that these funding problems are worsening and will continue to prevent S&WB from investing in necessary drainage capital improvements unless remedied.

The source of S&WB's funding of managing its portion of the city's drainage system, including capital, maintenance and operation expenses stem predominantly from a three-mill, six-mill and nine-mill property (*ad valorem*) tax dedications. As available, additional funding from federal and state government sources are also used; mostly towards eligible capital improvements. Unlike S&WB's potable water and sewerage operations, which can be funded with increased revenue from rate changes

and collection improvements, drainage funding is relatively fixed, changing annually based on the assessed value of real property in Orleans Parish. As operations costs have increased relative to this static annual funding source amount, the result has been that S&WB has lacked sufficient funds to address growing deferred infrastructure maintenance and has postponed numerous capital repair and improvement projects (See i.e., the 2016 - 2017 Drainage Budget Prioritization Projects below).

**5.6.2. S&WB TOTAL DRAINAGE BUDGET: ACTUAL REVENUE FROM DEDICATED PROPERTY TAX SOURCES**

2013: \$46,615,000 Actual Revenue

2014: \$47,474,000 Actual Revenue

2015: \$50,004,000 Actual Revenue

2016: \$56,659,000 Actual Revenue

2017: \$52,559,000 Actual Revenue

*Source: S&WB Comprehensive Annual Financial Report (CAFR) (2013-2017)*

By example, in 2015 S&WB's funding sources for drainage operations increased by 11% from 2014 to total approximately \$54 million. However, operation expenses also increased by 22%, totaling \$38 million. This total does not include repairs and facility maintenance. After debt service (\$2 million) and claims (\$1.2 million) are excluded, \$13,310,232 was available in 2015 for capital improvements, including replacements and improvements to pumping stations and the Drainage Department's pro rata share of power projects. Yet, S&WB's drainage capital expenditures for 2015 totaled \$20,727,040. Moreover, at year's end 2015, S&WB's anticipated capital improvement expenses for 2016 were estimated at \$89,618,200 with \$24,860,700 slated to come directly from S&WB (\$64,632,000 expected from the U.S. Army Corps of Engineers, FEMA and other sources).<sup>10</sup>

Based on the above operating revenue figures, S&WB's 2016 budget analysis held that for the period 2016 - 2020, S&WB would neither have "the capacity to issue additional bonds" nor "have the capacity to finance the major capital improvement program" during this four-year time period.<sup>11</sup> Indeed, the impact on meeting existing and immediate priority capital improvement is ongoing. As shown in Figure 57 and Figure 58, high priority projects are not budgeted or unfunded. Total budgeted but unspent funds for each type of infrastructure for 2012 - 2016 are shown in Figure 59. These figures illustrate that budgeted amounts are not spent because they are not available. Without additional revenues, money is not available to fund the necessary improvements. Major equipment repairs are deferred with resulting deterioration in operating conditions leading to significant equipment failures.

Left unchanged, this imbalance in S&WB's drainage operations funding structure will leave intact current vulnerabilities that stem from being unable to fund critical maintenance and drainage asset improvements. S&WB's 10-year capital plan (2017 - 2026) for drainage operations totals \$908.1 million. Assuming the continued reliance on existing tax dedications with no new local revenue source, S&WB

---

<sup>10</sup> See Black & Veatch, Report on Operations for 2015, pgs. 71-86.

<sup>11</sup> Id at p. 73.

estimates that \$502.6 million of those capital improvements would be deferred.<sup>12</sup> Moreover, two separate analyses commissioned by S&WB hold that based on projected revenue intake and increasing operations and routine maintenance costs, S&WB will have negative annual cash flow to be used for pump and power related investments by 2021, ranging from -\$3.3 million to -\$12.3 million.<sup>13</sup>

Aside from increasing operational expenses, projected reinvestment in assets and capital improvements between 2016 and 2020 is expected to reach \$51 million per year from S&WB.<sup>14</sup> Further, S&WB will assume several other substantial drainage related obligations over the coming years. Beginning in 2019, S&WB must begin payment on its 35% share of the recent and ongoing Southeast Louisiana Urban Flood Control (SELA) Projects with the remainder paid from U.S. Army Corps of Engineers funds. S&WB can pay its share over 30 years but anticipates annual payments of up to \$8.8 million in 2022 through the remainder of the repayment period. Annual operations and maintenance are expected to cost \$1.2 million annually by 2026.<sup>15</sup> S&WB further estimates that it will need an additional \$4 million annually for currently deferred maintenance of existing infrastructure and equipment paired with an estimated \$2 million annually for groundwater management and green infrastructure investments.

Based on these expanding costs and upcoming obligations, S&WB's commissioned analysis of its drainage operations as of 2015 offered the below assessment, which if left unaltered, would severely hamstring any efforts by S&WB to remedy those assets related causal factors of the Loss Events:

*The analysis indicates that the current revenue sources are not adequate to meet operation and maintenance expenses and total debt service on existing bond issues beginning in 2020. In addition, the Drainage Department will not have the debt capacity to fund all of the capital requirements through 2020. Due to constraints on revenue, it is anticipated that capital projects during the 5-year period will exceed the amount of funding available from the Drainage Department. It is recommended that the Board defer capital projects until an additional source of operating revenue has been identified and the SWBNO has the capacity to debt finance more projects.<sup>16</sup>*

---

<sup>12</sup> See, Black & Veatch, 10-Year Financial Plan for Water, Sewerage and Drainage Systems (2017-2026), November 2016, p. 23; see also, S&WB Drainage Capital improvement Program Financing Table (January 2017); and related analysis in "Beneath the Surface: A Primer on Stormwater Fees in New Orleans." Bureau of Governmental Research (February 2017), p.6. The remainder of S&WB 10-year Capital Improvement funding is estimated to be derived as follows: \$358 million in federal and other third-party funding; \$27 million in new drainage bonds; and \$20.5 million from drainage system cash flow.

<sup>13</sup> Information provided by S&WB (March 2017); see also, note 1 and 2016 analysis and drainage service fee study conducted by Raftelis Financial Consultants, Inc. The latter is a completed fee study and proposed structure but remains draft form.

<sup>14</sup> See n. 1

<sup>15</sup> "Beneath the Surface: A Primer on Stormwater Fees in New Orleans." Bureau of Governmental Research (February 2017), p.6

<sup>16</sup> See n. 1, p. 7, 75-76.

2016 Budget Prioritization - Drainage Department - Pumps*					
DPS	Project	Priority Level	Adopted Budget 2016	2016 Funding Status	Funded By
17	Rollup Door, HVAC for Office	10	\$ 1,012,900.00	Funded	FEMA
7	Repair to Discharge Tubes at DPS 7	9.64	\$ 6,500,000.00	Unfunded	S&WB
4	Repair/Replace suction basin canal, screen cleaners, vacuum header and pump: DPS 4	8.88	\$ 450,000.00	Unfunded	S&WB
19	Roof Repairs: DPS 19	8.75	\$ 200,000.00	Unfunded	S&WB
2	Enclosing a generator platform and refurbishment of a storage facility: DPS	8.62	\$ 200,000.00	Unfunded	S&WB
7	Clean and cover of a canal and installation of new screen cleaners	7.77	\$ -	Unfunded	S&WB
1	Replacement/Refurbishment of Constant Duty Pump	7.76	\$ 220,000.00	Unfunded	S&WB
6	Replacement/Refurbishment of 2 Constant Duty Pumps	7.76	\$ -	Unfunded	S&WB
3	Repar of DPS 3 gates and discharge tubes	7.66	\$ 400,000.00	Unfunded	S&WB
7	Purchase of three new vertical pumps	7.66	\$ -	Unfunded	S&WB
2	Repairs to Discharge Tubes	7.2	\$ -	Unfunded	S&WB
17	New Diesel Generator	6.96	\$ -	Unfunded	S&WB
6	Repair of 3 vertical pumps	6.49	\$ 340,000.00	Unfunded**	S&WB/Jefferson Parish
6	Increase to pump capacity of DPS 6	6.49	\$ 340,000.00	Unfunded**	S&WB/Jefferson Parish
4	New Pump Station across canal from DPS 4	5.57	\$ -	Unfunded**	S&WB, Corps. Of Engineers, SELA
6	Painting Outside Equipment	5.1	\$ -	Unfunded**	S&WB/Jefferson Parish
6	Remove the trash screen, fence, etc. and cover the ave C suction bay	5.1	\$ -	Unfunded**	S&WB/Jefferson Parish

\*Capital Projects Related to 8/5 Flooding Event  
 \*\*Combined amounts from each funding source.

Figure 57 2016 Budget Priorities - Pumps

2017 Budget Prioritization - Drainage Department - Pumps*					
DPS	Project	Priority Level	Adopted Budget 2017	2017 Funding Status	Funded By
17	Rollup Door, HVAC for Office	10	\$ 5,500,000.00	Funded	FEMA
7	Repair to Discharge Tubes at DPS 7	9.64	\$ 300,000.00	Unfunded	S&WB
4	Repair/Replace: Suction basin canal, Screen Cleaners, Vacuum header and pump	8.88	\$ 450,000.00	Unfunded	S&WB
19	Roof Repairs	8.75	\$ 200,000.00	Unfunded	S&WB
2	Enclosing a generator platform and refurbishment of a storage facility	8.62	\$ -	Unfunded	S&WB
1	Replacement/Refurbishment of Constant Duty Pump	7.76	\$ 220,000.00	Unfunded	S&WB
6	Replacement/Refurbishment of 2 Constant Duty Pumps	7.76	\$ 440,000.00	Unfunded	S&WB
3	Repar of DPS 3 gates and discharge tubes	7.66	\$ -	Unfunded	S&WB
7	Purchase of three new vertical pumps	7.66	\$ -	Unfunded	S&WB
2	Repairs to Discharge Tubes	7.2	\$ -	Unfunded	S&WB
17	New Diesel Generator	6.96	\$ -	Unfunded	S&WB
6	Repair of 3 vertical pumps	6.49	\$ 340,000.00	Unfunded**	S&WB/Jefferson Parish
6	Increase the pump capacity of DPS 6	6.49	\$ 340,000.00	Unfunded**	S&WB/Jefferson Parish
4	New Pump Station across canal from DPS 4	5.57	\$ -	Unfunded**	S&WB, Corps. Of Engineers, SELA
6	Painting Outside Equipment	5.1	\$ -	Unfunded**	S&WB/Jefferson Parish
6	Remove the trash screen, fence, etc. and cover the ave C suction bay	5.1	\$ -	Unfunded**	S&WB/Jefferson Parish

\*Capital Projects Related to 8/5 Flooding Event  
 \*\*Combined amounts from each funding source.

Figure 58 2017 Budget Priorities - Pumps

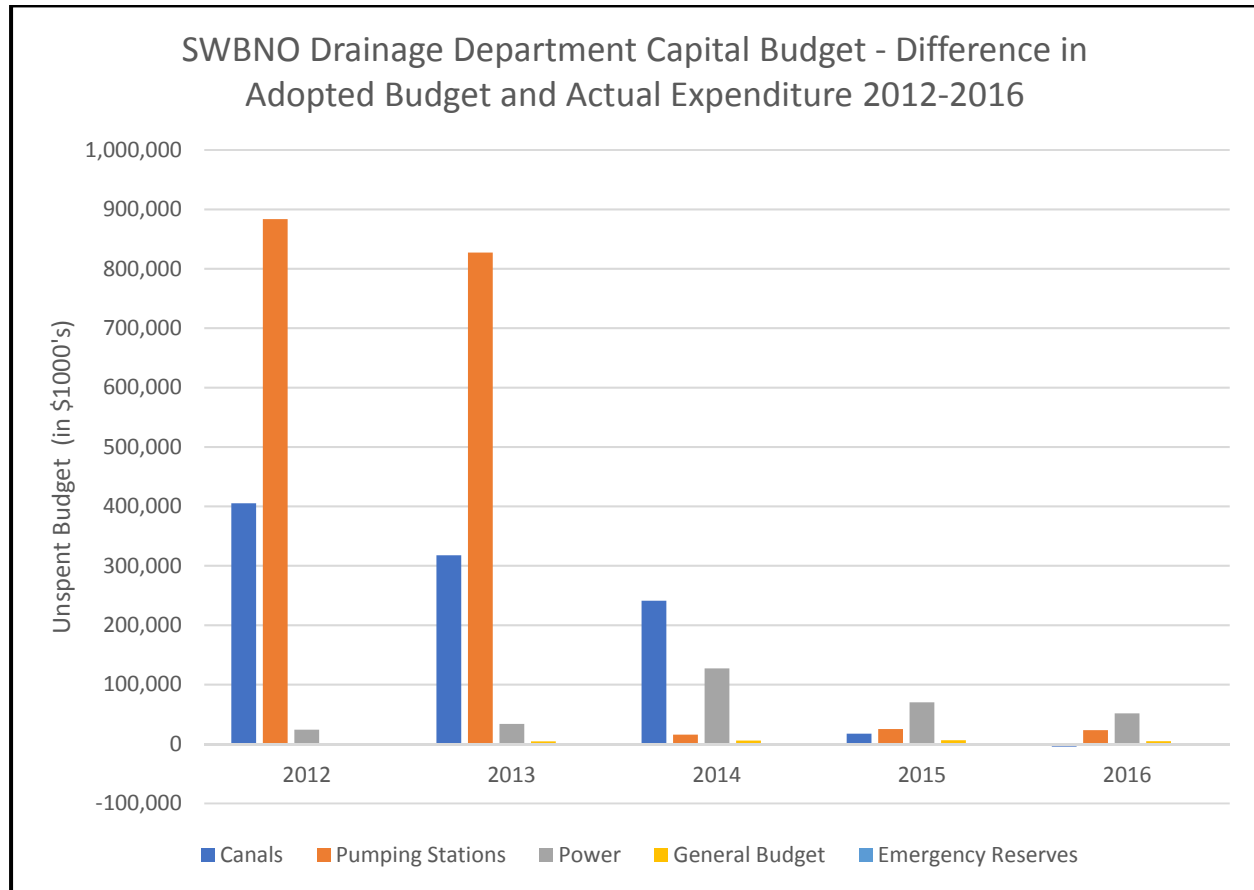

**Figure 59 Unspent Budget for Capital Improvement**

**5.6.3. THE CHILL EFFECT OF THE DECEMBER 2016 EXPIRATION OF ONE OF S&WB'S THREE PROPERTY TAX REVENUE SOURCES**

Revenue from the three-mill, six-mill and nine-mill ad valorem taxes that S&WB receives annually is the near exclusive local source by which S&WB endeavors to meet drainage related operating expenses, debt service and capital expenditures. In years leading up to the Loss Events, the three-mill tax source was scheduled to expire in December 2016 unless extended by a majority vote of the electorate in October 2016. Given the above noted funding limitations relative to costs, if that millage expired, then S&WB would not have sufficient funds to meet operating expenses and existing debt obligations.<sup>17</sup> Capital expenditures would not have been an option.

Several S&WB Board Members and managers who were interviewed indicated that this prospect of not having in place the three-mill revenue source – or another local funding source in its place – compelled further delays on pursuing outstanding maintenance needs, equipment replacements and capital improvements among drainage related assets.

<sup>17</sup> See n. 1, p. 75.

**5.6.4. HESITANCY TO PURSUING ALTERNATIVE OR SUPPLEMENTAL LOCAL FUNDING SOURCES FOR DRAINAGE OPERATIONS NEEDS**

S&WB estimates that the combined S&WB/City drainage system will require an *additional* \$54.5 million annually (\$40MM for S&WB portion; \$14.5MM for City portion) by 2026 just to meet then-existing obligations and to properly maintain all aspects of the system.<sup>18</sup> This is approximately twice the amount collectively available annually to S&WB and the City to manage their respective portions of the city's drainage system. Mindful of the above noted present funding deficiencies and vulnerability to expiring tax millages, S&WB's own analysis strongly recommends the creation of a new local funding source in the more immediate term or capital improvement projects will need to be deferred.<sup>19</sup>

Given these costs burdens, S&WB and City officials have been considering whether to pursue a drainage service fee, in lieu of new property taxes whereby a fee would be charged on each parcel based on size and discounted based on the volume of storm water retained onsite or otherwise prevented from entering into the city's drainage system. Such a fee was proposed in the City's Stormwater Capital Improvement Plan in 2010 and several other civic and governmental assessments since. In fact, in 2015 S&WB commissioned a full drainage fee study and structure to be conducted. That report was indicated to be completed based on interviews and examination of redacted content from the study. Nonetheless, the report remains in draft form and unavailable for public review and discourse.

**5.6.5. S&WB DRAINAGE RELATED BUDGETING PROCESS SHORTCOMINGS**

Tellingly, most of the analysis made available examining S&WB's drainage funding structure for the years leading to the Loss Events comes from reports that were completed 6 - 10 months after the fiscal year examined. Based on a review of S&WB Board meetings, minutes, agendas and finance related documents, there does not appear to exist in practice any opportunity by which the Board, New Orleans City Council, or the public at large can assess progress on operations, maintenance and capital expenditures during the course of a fiscal year. While such record-keeping and analysis may be conducted by S&WB staff it is not apparent that it leads to any process through which performance monitoring, troubleshooting on project implementation delays, or funding strategies can be focused upon and modified as needed during the real-time course of operating the drainage system.

Mindful that the above noted funding limitations and/or competing obligations and needs were undercutting S&WB's ability to assure sufficient maintenance and investment in power and pump related assets, the budgeting process in practice was another additional impediment to better oversight and troubleshooting of asset related causal factors of the Loss Events.

---

<sup>18</sup> See n.6, p.13, 23.

<sup>19</sup> See n.1, p. 7, 75-76; see also, "*Beneath the Surface: A Primer on Stormwater Fees in New Orleans.*" n.6, p.23 "Assuming \$40 million in new revenue beginning in 2019, the S&WB projects the following sources of capital funding: \$392 million in new drainage bonds, \$358 million in federal and other third-party funding, \$227 million in annual cash flow, \$5 million in existing funds and \$3.3 million in interest earnings. This would fund the entire \$908.1 million capital improvement plan and \$6.1 million of related costs (primarily bond issuance costs) and it would leave \$71.1 million in funds available for capital spending after 2026."



### 5.7. S&WB AND CITY-DPW DRAINAGE SYSTEM GOVERNANCE

Several aspects of how the City and S&WB govern, fund and operate their respective portions of the city's drainage system were root causes of asset and operations related causal factors giving rise to the rainfall related Loss Events. Specifically, the divided governance of the drainage system results in separate and inconsistent capital and operational budgeting, oversight, performance standards and public communications. These disconnects resulted in both citizens and governmental leaders lacking sufficient situational awareness that increasingly offline power turbines, inadequately maintained pump assets and chronically clogged, deteriorating and undersized catch basins and drain lines were collectively increasing the risk of flooding from severe rain events. Further, this divided management structure limits the effectiveness of S&WB and City budgeting, operations and oversight to separately address drainage system needs and vulnerabilities on an ongoing basis given, mindful of the year-round potential for severe rain events. In short, the current divided S&WB and City governance strategies for city drainage is incompatible with assuring that the city's single storm water protection system is managed and operated to achieve otherwise feasible flood risk reduction during severe rain events.

The following analysis identifies specific governance, oversight and policy issues that present as root causes of many of the infrastructure and operations related causal factors of the rainfall related Loss Events. In this, each identified disconnect or shortcoming was found to have a direct nexus to Loss Events causal factors and otherwise hindered the ability of government and the public to foresee and correct emerging problems within the drainage system.

#### **Differing Standards of Performance for S&WB and City Controlled Portions of City's Stormwater Protection System**

*Separate City and S&WB performance standards to manage their respective portions of the city's drainage system deprives both governmental entities and the community with accurate gauges by which to assess whether system designs, budgets and operational and maintenance strategies are compatible with what is needed to realize achievable storm water management capacity and flood risk reduction.*

**Details:** Since 1992, capital investment, maintenance and operations of the City's drainage system from catch basins to outfall canals have been divided between S&WB and the City.<sup>20</sup> S&WB controls the system beginning at subsurface pipes that are 36 inches and larger in diameter, while the City controls all catch basins and minor drain lines under 36 inches in diameter through the City Department of Public Works (DPW). This has resulted in the City's critical storm water protection system being artificially separated in terms of design and performance modeling, budgeting for capital improvements and maintenance and operating before and during severe weather events.

This division of a single functioning drainage system has also resulted in both governmental entities creating separate and incompatible standards by which to establish their respective expectations and define success in managing their respective portions of the system. S&WB officials hold that the standard of performance for their portion of the drainage system is to assure that one-inch of surface

---

<sup>20</sup> A 1992 Cooperative Endeavor Agreement between the City and S&WB establishes that the replacement of "all drainage lines smaller than thirty-six inches (36") in diameter, or the equivalent in arched pipe; all catch basins and catch basin laterals; and manholes designed to accommodate lines less than thirty-six inches in diameter... should normally be performed as part of a Street Capital Construction Improvement Project" which is within the jurisdiction of the City of New Orleans government and administered there by the Department of Public Works.

water is pumped and removed from the City's drainage basins in the first hour of a rain event and a half-inch of surface water for every hour thereafter.<sup>21</sup> This standard was first articulated by S&WB in the early 20<sup>th</sup> Century when its large "Wood Screw" pumps were first installed as a way to estimate the flow rate needed to evacuate a set amount of drainage acreage from the City's drainage basins as they existed at the time.<sup>22</sup> Importantly, this standard of performance does not consider nor evaluate the effectiveness of City controlled drainage assets to help achieve this flow rate (catch basins and minor drain lines allowing surface water to enter into larger culverts, pump stations and canals) nor does it reflect the current built environment of New Orleans, which has considerably more impervious surface area than when the Wood-Screw pumps were first installed. Instead, S&WB determines whether it meets this standard based solely on gauges within its pump stations. Tellingly, interviewed S&WB officials hold that S&WB met its performance standard during the Loss Events, despite the large number of offline turbines and pump assets, because the 1-inch/0.5-inch pump rate of water that entered into the system was thought to have been achieved. The system was at met least 80% of the target level at its peak, although not the entire period of the rain event, but flooding still occurred. The system had the capability to perform better than the target but was unable to reach the installed capacity due to equipment out of service, inadequate power supply and power distribution system limitations.

For its part, the City evaluates the performance of its portion of the storm water protection system based on a completely different "consumer" response-based standard. Rather than modeling and assessing the extent to which catch basins and minor drain lines assist or impede in draining the City's basins, whether by helping achieve S&WB's 1-inch/0.5-inch rate or some other hydrologic based metric; the City establishes and evaluates its performance (and budgets accordingly) by establishing an annual targeted number of 7,000 catch basins and drain lines to be cleaned based on citizen call-ins (via 311 issue flagging call number) and City Council member complaints.<sup>23</sup>

**Root Cause Impact:** The City and S&WB's long-standing practice of jurisdictionally dividing the city's drainage system contributed to creating the causal factors of the Loss Events by stymying the ability of S&WB and City officials to develop a comprehensive performance standard or Level of Service for the city's single functioning storm water protection system. This lack of a single, or at least coordinated, performance standard, prevents local government from knowing the true design capacity of the existing system; the level of service and risk to be expected from the current system amid rain events of graduated intensity; and the highest and best use of public policy and funding investments to improve the system and address inherent vulnerabilities. As such, S&WB and City drainage-related capital and maintenance funding sources and budgets that might otherwise have been structured over a sufficient period of time to minimize risks from storms such as what were experienced during the Loss Events were instead constructed in isolation to meet incongruent aims only tangentially related to reducing standing water within low lying drainage basins.

---

<sup>21</sup> See e.g., "S&WB Chief: No system could have handled that rain." WWLTV Interview of S&WB Executive Director Cedric Grant (August 5, 2017). Available online at: <https://www.wwltv.com/article/news/local/orleans/swb-chief-no-system-could-have-handled-that-rain/462264393>

<sup>22</sup> For full discussion of the history and rationale for this pumping rate related performance benchmark, see RCA Report, Section 4: Incident Descriptions and System Performance - *Pumping System Performance*.

<sup>23</sup> Interviews with Dani Galloway, Acting Director of Department of Public Works (DPW) (September 2017-May 2018); and Colonel Mark Jernigan, former DPW Director (2011-2017); see also, City Operating Budgets, DPW "Budgeting for Outcomes" Goals (2011-2017).

**Inconsistent Oversight, Risk Comprehension and Follow-Up Related to Known or Knowable Problems within S&WB & City Controlled Portions of the Drainage System**

*Emergency spending authorizations by S&WB leadership and the Board of Directors at least as early as March 2017 for power and pump system related repairs did not result in any apparent follow-up, inquiry, or analysis by City, S&WB, or City Council leadership, including tracking repair progress or evaluating the collective impact that multiple offline pumps and power assets might have in term of contributing to flooding during severe weather events.*

**Details:** On March 13, 2017 before the S&WB’s Finance & Administration Committee and again on March 15, 2017 before the full S&WB Board of Directors, Mayoral representatives and the general public via video recording; S&WB’s Executive Director and General Superintendent sought Board ratification of a proposed emergency declaration to use funds without normal procurement processes to address significant problems with S&WB’s turbines, which began on March 7. The seriousness of the problem is clear in the statements offered by senior staff to the Board and Mayoral representatives. Specifically, in seeking emergency ratification, the S&WB Executive Director explained to the Board that “fairly serious issues” were afoot with “Turbines 1, 3,4 and 5;” having “lost ability to generate 25-cycle power on March 7, 2017.”<sup>24</sup> As further noted to meeting attendees by the S&WB General Superintendent:

“We were headed for a blackout. For a time, we did not have the ability to generate power at the Sewerage and Water Board.”<sup>25</sup>

As further noted by the S&WB Executive Director, the failure of all of S&WB’s primary turbines for the drainage system “met the test of extreme emergency.”<sup>26</sup> While some of these assets were returned to limited service prior to the March 15 Board meeting, S&WB leadership indicated a solution towards stabilizing power generation would require 4-6 weeks from the point of that meeting.<sup>27</sup> Ultimately at both the Finance Committee and General Board meetings, emergency ratifications was unanimously approved by the Board without discussion except one Member stating, “That’s scary.” in response to the breadth of the problem articulated by senior staff.<sup>28</sup>

In the four months that followed leading to the Loss Events, the Finance & Administration committee of the S&WB met each of those months and the full Board met another four times, including a June planning retreat. Based on video recordings and meeting minutes, the matter of these faltering turbines and the emergency project authorized to address them were not discussion items at any of these meetings – or any other S&WB board committee meetings held during this time. During this timeframe, Turbine #3 would again falter in May and remain offline through the Loss Events. Subsequently, Turbine #5 would similarly fail in July leaving S&WB with less than the necessary capacity to generate 25-cycle power, weeks away from the onset of the Loss Events. Neither of these events was introduced as

---

<sup>24</sup> March 13, 2017 S&WB Board Finance and Administration Committee Meeting (Video Transcript, 0:34 minutes – 1:30 minutes). Available at:

[https://www.swbno.org/form\\_video.asp?s=news&id=581&vid=finance%20031317.mp4](https://www.swbno.org/form_video.asp?s=news&id=581&vid=finance%20031317.mp4).

<sup>25</sup> Id (Video Transcript, 1:51 minutes – 2:03 minutes).

<sup>26</sup> Id (Video Transcript, 1:20 minutes – 1:50 minutes).

<sup>27</sup> Id.; see also, March 15, 2017 S&WB Board of Directors Meeting (Video Transcript). Available at:

[https://www.swbno.org/form\\_video.asp?s=news&id=582&vid=board%20031517.mp4](https://www.swbno.org/form_video.asp?s=news&id=582&vid=board%20031517.mp4).

<sup>28</sup> March 13, 2017 S&WB Board Finance and Administration Committee Meeting (Video Transcript, 2:05 minutes).

agenda items at coinciding Board committee or general member meetings.<sup>29</sup> Moreover, while S&WB leadership were called to testify before the City Council of New Orleans' Public Works, Sanitation and Environmental Committee on June 25, 2017 to discuss, among other items "*Detailed reports on assessment and status of operational reforms, capital improvement programs, and service assurance programs,*" it was not apparent from available minutes and video transcripts that the ongoing failures of Turbines 1, 3 and 5 were inquired into or discussed as ongoing problems that required emergency action in an attempt to resolve.<sup>30</sup>

Importantly, while state law authorizes the S&WB Executive Director and General Superintendent to pursue bid-less emergency repairs upon ratification by the S&WB Board of Directors, that provision does not require any specific follow-up or oversight protocols.<sup>31</sup> Similarly, there are no local ordinances, policies, or procedures that would require and guide follow-up inquiry, tracking and analysis of emergency declaration such as what was set in motion in March 2017; whether by the S&WB Board of Directors, the City Council of New Orleans, or the City of New Orleans' emergency preparation and response entities.<sup>32</sup> Equally problematic, interviewed S&WB managers and board members acknowledged there is a lack of uniform standards to guide when emergency declarations are pursued and a similar lack of any graduated scale of urgency that might otherwise help leadership understand when declarations require closer oversight and scrutiny over time.<sup>33</sup>

**Root Cause Impact:** The failure of local governmental leadership to consistently track, assess and evaluate progress on completing emergency funded projects, particularly those involving multiple drainage related turbine or pump system failures, hampers any ability to gain situational awareness of emerging or existing risks presented by the collective impact of such faltering assets. Both City and S&WB controlled drainage assets suffer from being in a chronic state of disrepair and malfunction. Absent clear protocols that would require more stringent and consistent Board and elected leadership oversight of emergency matters, especially involving large-scale drainage power and pump problems and repair needs drainage; crises such as what emerged in March 2017 and continued through the Loss Events, hide in plain sight amid a backdrop of countless other challenges. Consequently, otherwise feasible contingency measures, risk communication and public safety and property protection safeguards are not explored and pursued in a timely manner. One need only examine the various extraordinary measures pursued by S&WB and City leadership *after* the Loss Events to provide back-up power, fast track power and pump system repairs and inspect and clear compromised catch basins and drain lines to appreciate the type of missed proactive measure that more vigorous oversight can provide.

---

<sup>29</sup> At the May 2017 S&WB Board of Directors meeting, several pump system related "current emergency bid contracts" were agenda items for approval and at the July 2017 Board of Directors meeting, the approval of "emergency bid letters" were agenda items. However, no bids or updates relative to the March emergency authorizations were agenda topics.

<sup>30</sup> See City Council of New Orleans' Public Works, Sanitation and Environmental Committee Meeting Agenda (June 25, 2017). Available at: [http://cityofno.granicus.com/GeneratedAgendaViewer.php?view\\_id=3&event\\_id=191](http://cityofno.granicus.com/GeneratedAgendaViewer.php?view_id=3&event_id=191)

<sup>31</sup> See, La R.S. 33.4084.

<sup>32</sup> Corroborated via interviews with current and former S&WB officials and board members in addition to available policies and procedures governing S&WB Board activities and the City Council of New Orleans.

<sup>33</sup> Id.

**Investment and Management of City Controlled Drainage Assets Incompatible with Assuring an Effective Level of Service for the Entire Drainage System**

*City controlled drainage assets are invested in and maintained using a performance standard, funding levels and bureaucratic processes that are incompatible with assuring a sufficient baseline of storm water protection. This resulted in avoidable catch basin and drain line blockages and deterioration, which contributed to standing surface waters in drainage basins impacted by the Loss Events.*

**Details:** Nearly two-thirds of the city’s stormwater protection system is under City control, including over 68,000 catch basins and approximately 1,288 miles of the city’s over 1,500 miles of drainage pipes. The City’s portion of the drainage system is the “on ramp” to the underground culverts, pump stations and canals controlled by S&WB. As such, S&WB’s pump and power assets are only as effective as the ability of City controlled drainage assets to allow surface water to enter into and traverse the overall drainage system. Data and interviews relative to the City’s management of its portion of the drainage system reveal that many catch basins and drain lines were compromised within the drainage basins most impacted by the Loss Events. Moreover, how the City funded and managed its portion of the city’s overall drainage system contributed to these assets being compromised and overall allows for significantly large number of clogged or collapsing catch basins and minor drain lines to exist at any given moment throughout the City.

Drainage modeling performed as part of the City’s \$3 million Stormwater Management Capital Improvement Plan in 2011 determined that a “10-year” rainfall event (8.5 inches over 24 hours) would inundate over 40% of the City with standing water of six inches to three feet based on the size and placement of catch basins and drain lines.<sup>34</sup> This finding was based solely on the size and orientation of existing drainage pipes and without consideration of blockages or leaks. Inherent to these findings is that clogged catch basins and drain lines would exacerbate even further the flooding during such severe rainfall events. Accordingly, the Plan recommended both a long-term program for replacing undersized drain lines as well a maintenance program to annually clean at least 8% of the underground drainage system, including 15% of known problem areas (200 miles of drain lines and 18,250 catch basins), along with video inspecting at least 8% of the underground drainage system (103 miles).

In the time from receiving those recommendations through the Loss Events, the City did not enact this dual strategy for upgrading and maintaining catch basins and drain lines within its control. To be sure, as capital improvement funds are available, the City has been replacing older, undersized drain lines with wider versions, including the use of approximately \$50 million in FEMA funding over the next 10 years.<sup>35</sup> However, both the nature of the City’s complementing drainage maintenance program and the bureaucratic process through it budgets and uses capital and maintenance funding is undercutting intended aims.

In lieu of pursuing the Stormwater Management Capital Improvement Plan’s recommended annual cleaning of 8% of the underground system, since at least 2011, the City has employed a more reactive,

---

<sup>34</sup> Performance assessments for how the city’s drainage system performs in rain events of varied severity were based on models of how Drainage Pump Station No. 1 would perform, then that data was extrapolated to estimate how the city’s entire drainage system would perform. This report remains in “draft” form.

<sup>35</sup> Interview of Colonel Mark Jernigan, former DPW Director (2011-2017); see also, “Beneath the Surface: A Primer on Stormwater Fees in New Orleans.” Bureau of Governmental Research (February 2017), p.7.

complaint-driven approach to catch basin and drain line cleaning as part of DPW's overall "roadway maintenance" budget program. Between 2011 and 2017, DPW's annual operating budget for "roadway maintenance" was approximately \$4.2 million. This funding encompassed the cleaning of drains and catch basins, filling potholes, grading gravel roads and emergency road repairs.<sup>36</sup> According to interviewed DPW officials, typically less than half of the annual roadway maintenance budget would be used for cleaning catch basins and drain lines. Based on these funding levels, DPW pursued a complaint-driven approach to drainage asset maintenance by setting annual target numbers of addressed citizen called-in or City Council derived complaints of clogged catch basins and drain lines.<sup>37</sup>

In 2011, the City's stated goal was to "double the number of catch basins cleaned in 2011 from 3,300 [in 2010] to 8,000."<sup>38</sup> That year DPW cleaned 3389 catch basins.<sup>39</sup> In all, between 2011 and 2016, DPW would clean an average 4751 catch basins annually.<sup>40</sup> This total is 26% of the recommended number of catch basins that the City's Stormwater Management Capital Improvement Plan recommended be cleaned annually. Moreover, in basing catch basin cleaning on complaints, DPW has not employed a more strategic approach based on video inspecting lines in low lying drainage basins as also recommended by the Improvement Plan. Finally, no records as to the amount of drain lines also annually were made available.

Looking ahead, the City will need to invest significant more funds annually towards drainage maintenance if it is to assure an adequate baseline of clear and structurally intact catch basins and drain lines, especially in low lying drainage basins such as those most impacted in the Loss Events. As noted by interviewed DPW and S&WB officials, the \$26 million in emergency funds that was allocated by the New Orleans City Council in the aftermath of the Loss Events<sup>41</sup> to inspect and clean City-controlled catch basins and drain lines is significantly more in line with what an effective annual drainage maintenance program should be allocated in comparison to the funding levels received annually since at least 2011.<sup>42</sup>

---

<sup>36</sup> 2011 DPW Roadway Maintenance Budget, p. 240 (\$3,905,355), Available at: [https://www.nola.gov/nola/media/Mayor-s-Office/Files/2011%20Budget/2011\\_NOLA\\_ADOPTED\\_Budget-FINAL.pdf](https://www.nola.gov/nola/media/Mayor-s-Office/Files/2011%20Budget/2011_NOLA_ADOPTED_Budget-FINAL.pdf); 2012 DPW Roadway Maintenance Budget, p. 321 (\$3,156,273); 2013 DPW Roadway Maintenance Budget, p.315 (\$2,604,581); 2014 DPW Roadway Maintenance Budget, p. 329. (\$2,436,030); 2015 DPW Roadway Maintenance Budget, p. 320. (\$2,531,053); 2016 DPW Roadway Maintenance Budget, p. 327. (\$8,287,076); 2017 DPW Roadway Maintenance Budget, p. 329 (\$6,496,623).

<sup>37</sup> Id.

<sup>38</sup> 2011 City of New Orleans Operating Budget, Adopted, p. 22.

<sup>39</sup> 2015 City of New Orleans Operating Budget, Adopted, p. 662.

<sup>40</sup> 2012 (5364 catch basins); 2013 (3839 catch basins). 2015 City of New Orleans Operating Budget, Adopted, p. 662; 2014 (2780 catch basins). 2015 City of New Orleans Operating Budget, Adopted, p. 318; 2015 (7611 catch basins), 2016 (5526 catch basins). 2017 City of New Orleans Operating Budget, Adopted, p. 327. See note 36 for reference location

<sup>41</sup> [https://www.nola.gov/mayor/news/archive/2017/20170818-pr-correction-city-allocates-\\$26-million/](https://www.nola.gov/mayor/news/archive/2017/20170818-pr-correction-city-allocates-$26-million/)

<sup>42</sup> Interviews with Dani Galloway, Acting Director of Department of Public Works (DPW) (September 2017-May 2018); and Colonel Mark Jernigan, former DPW Director (2011-2017); "Estimated S&WB Costs in Responding to DPW Drainage Repairs." (Provided by S&WB to DPW, September 2011); see also, "Beneath the Surface: A Primer on Stormwater Fees in New Orleans." Bureau of Governmental Research (February 2017), p.7 "The S&WB anticipates that the Department of Public Works will need \$19.7 million annually to inspect, clean and maintain its system;" Beneath the Surface, p.25. "S&WB estimates this expense to begin at \$4 million in 2019 and gradually increase to \$19.7 million by 2023."

Funding levels and maintenance strategy aside, the types of funding employed and the process through which those monies are processed for use further hamstrings City efforts to assure an effective baseline functionality among its controlled drainage assets. The City typically funds its drainage asset improvement and maintenance program with a combination of general local funds and federal grants, including disaster recovery monies from FEMA and HUD, which can be considerably more complicated and burdened with regulations than general fund monies. For example, City officials interviewed held that it's the City's position that federal allocated for drainage purposes cannot be used for clearing clogged assets; but instead only to (re)constructing assets.<sup>43</sup> Further, the use of these monies involves regulatory processes, include derailed environmental assessments that are not otherwise required when using local general funds. Lastly, City protocols in place prior to the Loss Events required that environmental reviews be conducted by agency separate from DPW, therein adding additional bureaucratic process.<sup>44</sup>

Two examples of the difficulty of efficiently using this combination of local and federal funding for drainage maintenance and reconstruction are telling and germane to the Loss Events. First, in the aftermath of Hurricane Isaac which flooded portions of New Orleans in 2012, the City identified numerous catch basins and drain lines that were compromised by debris from the storm. Subsequently in 2013, FEMA awarded nearly \$6 million to inspect, clean and repair these assets. As part of this endeavor, the City mapped and scheduled the cleaning and repair of these assets, including catch basins and drain lines in the basins most impacted by the Loss Events. The process for using these funds would not commence until 2016.<sup>45</sup> Secondly, approximately \$6 million in funding was appropriated to DPW in the City's 2017 Operating Budget for drainage related maintenance, comprised mostly of additional federal monies from HUD and the BP Oil Spill legal settlement.<sup>46</sup> As of July 2017, less than \$400,000 of those appropriated funds had been cleared through related environmental review processes for use.<sup>47</sup> Consequently, there is no evidence that any appreciable number of known problematic city controlled drainage assets in the basin to be most impacted by the Loss Events were remedied beforehand.

**Root Cause Impact:** The inability to clean known problematic catch basins and drain lines in the basins most impacted by the Loss Events helped give rise to the drainage asset causal factor that contributed to the Loss Events. The City's long-standing and continued reliance on a reactive maintenance regime that, at best, addressed only a fraction of deteriorating and clogged City controlled drainage assets perpetuates this vulnerability in the face of future severe rain events.

### **Inadequate Long-term Funding Sources to Meet Deferred and Emerging Investment and Maintenance Needs through the City Drainage System**

*The inability of S&WB and City leadership to advance long-deliberated options for long-term funding of capital investment and maintenance of the entire drainage system locked the City's drainage related*

---

<sup>43</sup> Interview of Colonel Mark Jernigan, former DPW Director (2011-2017)

<sup>44</sup> Id.

<sup>45</sup> Id; see also, RCA Sections 2.2 and 5.2 for additional analysis of the impact of known compromised DPW drainage assets during the Loss Events.

<sup>46</sup> Interview with Katie Dignan, former City of New Orleans "Project Delivery Unit" Manager; and City of New Orleans Budgeting for Outcomes Assessments (2017) and DPW Operating and Capital Budgets (2017).

<sup>47</sup> Testimony of Mark Jernigan before New Orleans City Council, July 25, 2017.

*governmental entities into a situation where pump, power and drain line assets have continued to deteriorate with increasingly less resources for restoration, maintenance and functionality.*

**Details:** Other than three existing property tax millages dedicated to funding S&WB controlled drainage assets, there exists no dedicated funding source to maintain and improve the city's stormwater protection system. Since 2010, at least four separate formal assessments of best-practices for assuring a sustainably funded city drainage system have recommended the instituting of a parcel based drainage service fee discounted based on property runoff retention.<sup>48</sup> Indeed, in 2016 S&WB commissioned a now complete drainage fee structure that would assess a fee based on the size of the property and discount that fee by the volume of water retained or otherwise absorbed onsite before entering into the drainage system.<sup>49</sup> That report remains in "draft" form and has not been substantively advanced by S&WB, the Mayor's Office, or the City Council. Indeed, numerous current and former officials separately interviewed characterized the issue of advancing a drainage fee or another long-term funding source as a matter that top City and S&WB leadership decided would not be further pursued with the electorate under then current leadership.<sup>50</sup>

**Root Cause Impact:** Capital investment and maintenance for both S&WB's power and pump assets and the City's catch basin and drain line infrastructure are chronically underfunded relative to their respective stated needs and the functionality of the system as a whole. This lack of funding directly impacted the ability to restore and maintain those drainage assets that were not optimally functioning during the Loss Events and continues to fuel similar risk of future flooding exacerbated by faltering assets and inadequate system design.

---

<sup>48</sup> See e.g., City of New Orleans Stormwater Management Capital Improvements Plan (New Orleans Department of Public Works (2011); *Assessing the City & S&WB Drainage System: Recommendations for Enhancing New Orleans Stormwater Protection*; New Orleans Citizen Sewer, Water & Drainage System Reform Task Force (2012); Greater New Orleans Urban Water Plan (2013); *Drainage System Funding Feasibility Analysis* (Raftelis Financial Consultants) (June 2016); Bureau of Governmental Research Report (Non-Governmental) Report (2016).

<sup>49</sup> See, *Drainage System Funding Feasibility Analysis* (Raftelis Financial Consultants) (2016-2017).

<sup>50</sup> Scott Jacobs, Joseph Becker, Alan Arnold, Mark Jernigan Interviews; see also, statements made during "Save Our Streets" Task Force meetings (2015-2017).



**6. CAUSAL FACTORS AND ROOT CAUSES**

**6.1. FLOOD EVENTS**

There is a wide range of causal factors and intermediate causes for the flooding events. These cover S&WB operations as well as DPW and the City. Causal factors (equipment performance gaps and personnel performance gaps) are the direct causes of flooding but they are created by numerous intermediate causes which are interconnected in complex ways. The CAET was used to develop most plausible causal factors and intermediate causes which led to the causal factors. Root causes, which set the stage for the causal chain to occur, were then developed. The causal factors, key intermediate factors and root causes and the recommendation for the root causes are shown in the table on the following pages.

**Table 24 Causal Factors, Root Causes and Recommendation for Flood Loss Events**

Causal Factor	Intermediate and Root Causes	Recommendations
<b>Loss Event: Flooding</b>		
<p><b>Causal Factor 1:</b> There was insufficient 25 Hz power to supply all required pumps due to G3, G4 and G5 being out of service for maintenance.</p> <p><b>Background:</b> A portion of the pumps at DPS 2,3,4,6,7 and 12 which were available for operation were not able to be used simultaneously due to 25 Hz power shortages</p>	<p><b>Intermediate Cause 1.1:</b> Reliability issues with turbines generators were recognized and a plan was developed by S&amp;WB to repair and rehabilitate but these plans were not implemented adequately or in time to avoid loss of power generation at the time when flooding occurred</p>	
	<p><b>Intermediate Cause 1.2:</b> Deferred maintenance - FEMA funds were budgeted for G4 rehabilitation in 2017 but was not complete. Multiple deficiencies were discovered during the course of repair which delayed completion and increased cost</p>	
	<p><b>Intermediate Cause 1.3:</b> Deferred maintenance - Insufficient funding provided for G3 repair. Capital project CP 675-02 to refurbish G3 was not budgeted for 2016 or 2017. Funding pushed to subsequent year in each budget</p>	
	<p><b>Intermediate Cause 1.4:</b> Deferred maintenance - FEMA funds were budgeted for G4 rehabilitation in 2017 but was not complete</p>	

Causal Factor	Intermediate and Root Causes	Recommendations
	<b>Intermediate Cause 1.5:</b> Deferred maintenance - FEMA funds were budgeted for G5 rehabilitation in 2017 but was not complete	
	<b>Intermediate Cause 1.6:</b> Deferred maintenance – S&WB Board of Directors did not recognize the critical nature of the turbine power generation reliability	
	<b>Intermediate Cause 1.7:</b> Backup power supply was not provided, not planned or procured when turbine generator 3 and 5 became unreliable and went out of service	
	<b>Intermediate Cause 1.8:</b> There was recognition that backup power was necessary but was not provided	
	<b>Intermediate Cause 1.9:</b> There was no plan to implement backup power supply	
	<b>Intermediate Cause 1.7:</b> Increased use of internal power generation and decreased use of Entergy supplied power resulted in additional run times for turbine generators resulting in increased downtimes for repair and reduced reliability	
	<b>Root Cause 1.1: Insufficient Planning and Risk Awareness of Power Generation Systems:</b> S&WB management did not ensure adequate planning and actions for backup power to mitigate potential turbine generator outages and prevent critical power shortages	<p><b>Recommendation 1</b></p> <p><b>Recommendation 2</b></p>

Causal Factor	Intermediate and Root Causes	Recommendations
	<p><b>Root Cause 1.2: Inadequate Long-Term Funding Strategy to Address Known Problematic Turbines:</b> S&amp;WB Board of Directors did not ensure adequate funding of capital improvements to maintain turbine generator operations at an adequate level to meeting pumping requirements</p>	<p><b>Recommendation 3</b></p>
	<p><b>Root Cause 1.3: Increased Reliance &amp; Demand on Aging Turbines for Daily Non-Drainage Related Systems:</b> S&amp;WB strategic decision to increase the use of internal power generation assets without recognition of and provision for increased maintenance resulted in decreased power reliability</p>	<p><b>Recommendation 1</b> <b>Recommendation 4</b></p>
	<p><b>Root Cause 1.4: Inconsistent Leadership Oversight of Turbine Related Problems and Repairs:</b> Ineffective oversight of power system maintenance by S&amp;WB management and Board led to a lack of understating of the critical nature of the problems within the power generation system</p>	<p><b>Recommendation 5</b></p>
<p><b>Causal Factor 2:</b> There was insufficient 25 Hz power to supply all required pumps due to lack of available electrical feeders.</p> <p><b>Background:</b> A portion of the pumps at DPS 3, 7 and 12 which were available for operation were not able to be used simultaneously due to 25 Hz power shortages caused by lack of available electrical feeders</p>	<p><b>Intermediate Cause 2.1:</b> Design of the feeder network did not provide sufficient capacity to utilize available power from frequency changer 2</p>	

Causal Factor	Intermediate and Root Causes	Recommendations
	<p><b>Intermediate Cause 2.2:</b> Deferred maintenance - Insufficient funding provided for feeder replacement and repair. - Capital project CP 610-03, 04, 05, 06 to replace feeders were not budgeted for in 2017.</p>	
	<p><b>Root Cause 2.1: Inadequate Budgeted Funding for Inspection and Repairs:</b> S&amp;WB Board of Directors did not ensure adequate funding of capital improvements at an adequate level to maintain sufficient electrical feeders to meeting pumping requirements</p>	<p><b>Recommendation 3</b> <b>Recommendation 6</b></p>
<p><b>Causal Factor 3:</b> Continuous power not provided to all pumps causing them to trip offline.</p>	<p><b>Intermediate Cause 3.1:</b> Electrical feeders lost voltage during the event due to poor electrical integrity</p>	
<p><b>Background:</b> Feeders were in degraded condition and lost voltage frequently</p>	<p><b>Intermediate Cause 3.2:</b> Reliability issues with electrical feeders were recognized and a plan was developed by S&amp;WB to repair and rehabilitate but these plans were not implemented adequately or in time to avoid loss of power generation at the time when flooding occurred</p>	
	<p><b>Intermediate Cause 3.3:</b> Deferred maintenance - Insufficient funding provided for feeder replacement and repair. - Capital project CP 610-03, 04, 05, 06 to replace feeders were not budgeted for in 2017.</p>	
	<p><b>Intermediate Cause 3.4:</b> Voltage fluctuations occurred which caused frequency changers and pumps to trip offline</p>	

Causal Factor	Intermediate and Root Causes	Recommendations
	<b>Intermediate Cause 3.5:</b> Insufficient power supply from Entergy due to unreliable feeders (residential grade)	
	<b>Root Cause 3.1:</b> S&WB had inadequate proactive planning to assure inspections and repairs of feeders and protocols for alternative power sourcing and conveyance	<b>Recommendation 6</b>
	<b>Root Cause: 3.2: Funding – Inadequate Long-Term Funding Strategy to Address Known Power Conveyance Limitations and Problems:</b> S&WB Board of Directors did not ensure adequate funding of capital improvements at an adequate level to maintain sufficient electrical feeders to meeting pumping requirements	<b>Recommendation 3</b>
	<b>Root Cause 3.3: Continuous Reliance on Outage Prone Distribution Lines:</b> S&WB did not acquire commercially rated external power feeds resulted in unreliable power.	<b>Recommendation 7</b>
<b>Causal Factor 4:</b> There were insufficient operable pumps at DPS 6, 7 due to maintenance issues.	<b>Intermediate Cause 4.1:</b> S&WB did not address equipment issues early enough to perform maintenance during periods of low pumping demand. This led to pumps being inoperable in peak demand	
<b>Background:</b> 45% of pumping capacity at DPS 6 and 37% of pumping capacity were out of service due to pumps being down for maintenance.	<b>Intermediate Cause 4.2:</b> There was a plan and budget to complete repairs, but they were not completed in time to be available	
	<b>Intermediate Cause 4.3:</b> Board did not recognize the criticality of pumps which were not operable and potential impact on pumping capacity by drainage basin	

Causal Factor	Intermediate and Root Causes	Recommendations
	<p><b>Root Cause 4.1: Inadequate Pump Asset Maintenance Planning:</b> S&amp;WB management did not adequately manage repair activities to insure they were completed as quickly as possible</p>	<p><b>Recommendation 8</b></p>
	<p><b>Root Cause 4.2: Funding:</b> Inadequate Long-Term Funding Strategy to Address Deferred and Emerging Pump System Problems</p>	<p><b>Recommendation 3</b></p>
	<p><b>Root Cause 4.3: Oversight</b> - Inconsistent Leadership Oversight of Pump System Related Problems and Repairs</p>	<p><b>Recommendation 5</b></p>
	<p><b>Root Cause 4.4 Maintenance:</b> Pump maintenance was reactive rather than preventive</p>	<p><b>Recommendation 8</b></p>
<p><b>Causal Factor 5:</b> The drainage pumping system had inadequate design capacity to remove water from drainage basins</p>	<p><b>Intermediate Cause 5.1:</b> Rainfall intensity and duration) exceeded design capacity S&amp;WB storm water removal system. Actual storm on August 5 was 25-100-year storm frequency in DPS 3, 7, and 19. Design capacity of the system is approximately 2-year storm frequency</p>	
	<p><b>Intermediate Cause 5.2:</b> S&amp;WB storm water drainage system not designed for level of service typically used for urban areas (10-year storm). For New Orleans this is 8.5 inches of rain over a 24-hour period</p>	
	<p><b>Intermediate Cause 5.3:</b> S&amp;WB has not established minimum flow rates to prevent flooding during a design basis storm</p>	

Causal Factor	Intermediate and Root Causes	Recommendations
	<p><b>Root Cause 5.1: Performance Standards:</b>                      S&amp;WB operations management did not establish and maintain minimum conditions of operations</p>	<p><b>Recommendation 9</b></p>
	<p><b>Root Cause 5.2: Oversight:</b> S&amp;WB Board did not provide sufficient oversight activity to ensure the drainage pumping system was available to operate at design capacity and to establish minimum conditions of operations</p>	<p><b>Recommendation 5</b></p>
	<p><b>Root Cause 5.3: Inadequate Capital Improvement Assessment and Implementation Strategy Relative to Known Present Day Topography and Built Environment of New Orleans:</b>                      S&amp;WB Board of Directors did not develop plans to improve the drainage pumping system capacity to a level of service typically used for urban areas</p>	<p><b>Recommendation 10</b></p>
<p><b>Causal Factor 6:</b> Pumps were not moving water efficiently due to mechanical integrity issues</p>	<p><b>Intermediate Cause 6.1:</b> Pump mechanical integrity issues including corroded suction and discharge bells and unreliable vacuum breakers</p>	
	<p><b>Intermediate Cause 6.2:</b> S&amp;WB recognized mechanical integrity issues but did not adequately repair them</p>	
	<p><b>Intermediate Cause 6.3:</b> Mechanical integrity repair projects were unfunded in maintenance budget</p>	
	<p><b>Root Cause 6.1: Planning:</b> Inadequate Pump Asset Maintenance Planning</p>	<p><b>Recommendation 8</b></p>
	<p><b>Root Cause: 6.2: Funding:</b> S&amp;WB Board of Directors did not ensure adequate funding of capital improvements at an adequate level to maintain pumping capacity</p>	<p><b>Recommendation 3</b></p>

Causal Factor	Intermediate and Root Causes	Recommendations
	<p><b>Root Cause 6.3: Inconsistent Leadership Oversight of Pump System Related Problems and Repairs:</b> S&amp;WB Board of Directors did not provide sufficient oversight activity to ensure drainage pumping system was available to operate at design capacity to establish minimum conditions of operations</p>	<p><b>Recommendation 2</b></p>
<p><b>Causal Factor 7:</b> Pumps ran backwards for long durations reducing pumping capacity and recharging the suction basin</p>	<p><b>Intermediate Cause 7.1:</b> Voltage fluctuations occurred which caused frequency changers and pumps to trip offline</p>	
	<p><b>Intermediate Cause 7.2:</b> Vacuum breakers did not perform adequately to unload pumps resulting in backflow into the suction basin</p>	
	<p><b>Intermediate Cause 7.3:</b> S&amp;WB recognized mechanical integrity issues but did not adequately repair them</p>	
	<p><b>Intermediate Cause 7.4:</b> Braking system was not used</p>	
	<p><b>Intermediate Cause 7.5:</b> Mechanical integrity repair projects were unfunded in maintenance budget</p>	
	<p><b>Root Cause 7.1: Inadequate Pump Asset Maintenance Planning:</b> S&amp;WB management did not adequately manage repair activities to insure they were completed as quickly as possible</p>	<p><b>Recommendation 5</b></p>



Causal Factor	Intermediate and Root Causes	Recommendations
	<p><b>Root Cause 7.2: Inadequate Long-Term Funding Strategy to Address Deferred and Emerging Pump System Problems:</b> S&amp;WB Board of Directors did not ensure adequate funding of capital improvements at an adequate level to maintain pumping capacity</p>	<p><b>Recommendation 3</b></p>
	<p><b>Root Cause 7.3: Inconsistent Leadership Oversight of Pump System Capacity Limitations and Problems:</b> S&amp;WB Board of Directors did not provide sufficient oversight activity to insure drainage pumping system was available to operate at design capacity</p>	<p><b>Recommendation 2</b></p>
<p><b>Causal Factor 8:</b> DPW drainage pipes were clogged and broken</p>	<p><b>Intermediate Cause 8.1:</b> DPW recognized they were clogged and broken but did not adequately clean and repair them.</p>	
	<p><b>Intermediate Cause 8.2:</b> There was a plan to clean and repair the minor piping system, but it had not been executed</p>	
	<p><b>Intermediate Cause 8.3:</b> There was no approved funding for executing cleaning and repair plans</p>	
	<p><b>Root Cause 8.1:</b> Inadequate Long-Term Capital Improvement and Maintenance Planning Based on City Controlled Drainage System Importance and Vulnerabilities</p>	<p><b>Recommendation 3</b> <b>Recommendation 11</b> <b>Recommendation 12</b></p>
	<p><b>Root Cause 8.2:</b> Inadequate Funding for Departmental Drainage Maintenance and Investment Requests - City administration did not provide sufficient funding for cleaning and repair of DPW drainage piping</p>	<p><b>Recommendation 3</b> <b>Recommendation 11</b> <b>Recommendation 12</b></p>

Causal Factor	Intermediate and Root Causes	Recommendations
	<p><b>Root Cause 8.3:</b> Bureaucratic Inefficiencies and Limitations Hamstrung the Ability to More Proactively and Expeditiously Clean Clogged Drain Lines</p>	<p><b>Recommendation 3</b></p> <p><b>Recommendation 11</b></p> <p><b>Recommendation 12</b></p>
<p><b>Causal Factor 9:</b> Catch basins and inlets were clogged and broken</p>	<p><b>Intermediate Cause 9.1:</b> DPW recognized they were clogged and broken but did not adequately clean and repair them</p>	
	<p><b>Intermediate Cause 9.2:</b> There was a plan to clean and repair the catch basins and inlets, but implementation was significantly delayed</p>	
	<p><b>Intermediate Cause 9.3:</b> Terms of FEMA grant delayed implementation</p>	
	<p><b>Intermediate Cause 9.4:</b> There was no reliable source of funding to implement the plan</p>	
	<p><b>Root Cause 9.1:</b> Inadequate Long-Term Capital Improvement and Maintenance Planning Based on City Controlled Drainage System Importance and Vulnerabilities                      – City Department of Public Works did not provide adequate assessment and maintenance planning for the City’s portion of the storm drainage system</p>	<p><b>Recommendation 3</b></p> <p><b>Recommendation 11</b></p> <p><b>Recommendation 12</b></p>
	<p><b>Root Cause 9.2:</b> Inadequate Funding for Departmental Drainage Maintenance and Investment Requests - City administration did not provide sufficient funding for cleaning and repair of DPW catch basins and inlets</p>	<p><b>Recommendation 3</b></p> <p><b>Recommendation 11</b></p> <p><b>Recommendation 12</b></p>
	<p><b>Root Cause 9.3:</b> Bureaucratic Inefficiencies and Limitations Hamstrung the Ability to More Proactively and Expeditiously Clean Clogged Drain Lines</p>	<p><b>Recommendation 3</b></p> <p><b>Recommendation 11</b></p> <p><b>Recommendation 12</b></p>

Causal Factor	Intermediate and Root Causes	Recommendations
<p><b>Causal Factor 10:</b> DPW minor piping system had insufficient design drainage capacity</p>	<p><b>Intermediate Cause 10.1:</b> Deficiencies in design of the minor piping were identified but were not addressed in the capital improvement program</p>	
	<p><b>Root Cause 10.1:</b> Inadequate Dedicated Long-term Funding &amp; Policy Support - City administration did not provide sufficient funding for improvements in the DPW drainage system</p>	<p><b>Recommendation 3</b> <b>Recommendation 12</b></p>
<p><b>Causal Factor 11:</b> Rainfall in three drainage basins exceeded design storm for the DPW drainage system</p> <p><b>Background:</b> The S&amp;WB/DPW system design basis is a 10-year storm. The rainfall on August 5 exceeded this storm frequency in drainage basins 2, 3 and 19</p>	<p><b>Root Cause 11.1:</b> The amount of precipitation that fell during the Loss Event and then migrated to lower lying drainage basins was more volume of water than what the City’s total amount of catch basins and minor lines in those areas could store so as to prevent standing waters in excess of 6 inches.</p>	<p><b>Recommendation 13</b></p>
<p><b>Causal Factor 12:</b> Rainfall in four drainage basins exceeded design storm for the S&amp;WB drainage pumping system</p> <p><b>Background:</b> The S&amp;WB system design basis is approximately equivalent to a 1.5-year storm. The rainfall on August 5 exceeded this storm frequency in drainage basins 2, 3, 7 and 19</p>	<p><b>Root Cause 12.1:</b> The amount of precipitation that fell during the Loss Event and then migrated to lower lying drainage basins was more volume of water than what S&amp;WB’s portion of the drainage system, including fully functioning turbines and pumps, could convey through drain lines to outfall canals to prevent standing waters in excess of 6 inches.</p>	<p><b>Recommendation 13</b></p>

**6.2. TURBINE GENERATOR #1 ELECTRICAL FAULT AUGUST 9, 2017**

Potential causes of the arcing and resulting fire were developed by the ABS Group team. These were identified as potential causal factors and incorporated into a CAET in Figure 60. For arcing to occur, there must be current passing through the rotating arm. In the manual mode, current flows through the arm but this mode is only used in emergencies so there is a short period of time current would be flowing in the correct wiring configuration. Since current was flowing through the manual rheostat even in automatic field control mode, potential for brush contact arcing was significantly increased.

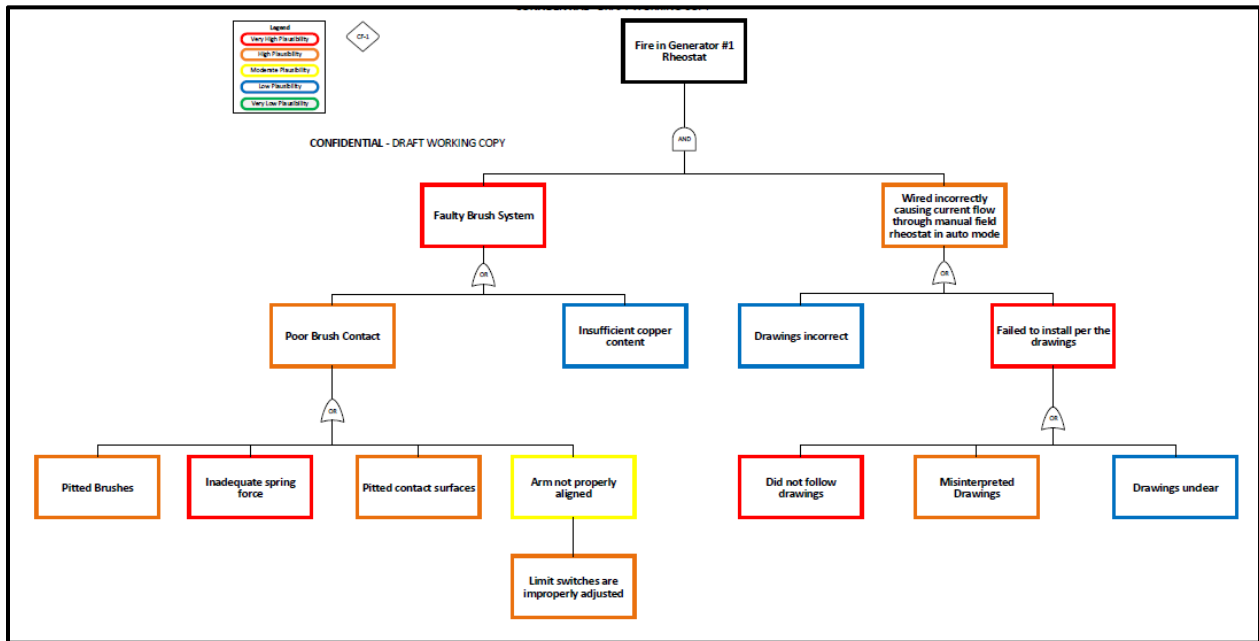

**Figure 60 Cause and Effect Tree for Turbine Generator 1 Electrical Fault**

Arcing can occur when there is pitting in the contact surfaces. Any arcing will increase pitting and continue a cycle of increased damage to the contact surfaces. Another potential cause of arcing is low or uneven spring force on the brushes. This allows for poor contact between the brush and switching segments giving rise to arcing. Since there are two brushes different spring tensions can cause one brush to conduct more current than the other. This would increase the temperature rise of the brush carrying more current. Increased spring temperature caused by brush current imbalance can weaken the springs and reduce the force holding the brushes against the contact surfaces.

Over-travel of the rotating arm could also create an arcing condition, which might be caused by misalignment of limit switches.

Insufficient copper content in the brushes can also be a contributing factor for arcing. Brushes used by the electrician staff were taken from parts remaining from the last refurbishment of G1. Specification of the brushes or springs were not known.

The most probable causal factors and associated intermediate causes are:

1. Faulty brush system due to inadequate spring force on the brushes

2. Incorrect wiring of the manual field rheostat due to failure to follow the drawings

A summary of causal factors, intermediate causes, root causes and recommendations are shown in Table 25.

**Table 25 Causal Factors, Root Causes and Recommendation for Turbine Generator 1 Electrical Fault**

Causal Factor	Intermediate and Root Causes	Recommendations
<b>Loss Event: Turbine Generator 1 Fire</b>		
<p><b>Causal Factor 1:</b> Wiring for field rheostat was installed incorrectly</p> <p><b>Background:</b> When the G1 field rheostat failure on August 9, expeditious repairs were required because G1 was the only available turbine generator. Maintenance personnel installed the new equipment and connected electrical components. Sufficient testing was not performed to detect the wiring error to ensure that current was not flowing through the manual rheostat during automatic field control mode</p>	<p><b>Intermediate Cause 1.1:</b> Personnel did not verify correct wiring in accordance with drawings</p> <p><b>Intermediate Cause 1.2:</b> Personnel did not perform adequate tests of the installation to detect the wiring error</p> <p><b>Root Cause 1.1:</b> Detailed procedures for repair of critical equipment were not developed by S&amp;WB</p>	<p><b>Recommendation 1:</b> S&amp;WB should develop procedures for repair of critical equipment which requires adequate testing and independent checks</p>
<p><b>Causal Factor 2:</b> Inadequate and inconsistent spring force on brushes</p>	<p><b>Intermediate Cause 2.1:</b> Heating of the rotating arm caused by constant current flow reduced spring force</p>	<p><b>Recommendation 2:</b> S&amp;WB should consult with an application engineer with a reputable brush supplier to develop configuration control for field rheostat equipment to include mechanical, electrical and chemical properties</p>
<p><b>Background:</b> Weak or inconsistent spring pressure allows arcing to occur. Current was flowing full time through the field rheostat subjecting the spring to much more thermal load and anticipated in the design</p>	<p><b>Intermediate Cause 2.2:</b> Required spring force for this application was not known</p>	<p><b>Recommendation 3:</b> S&amp;WB should prepare preventive maintenance plans for field rheostats to include:</p> <ul style="list-style-type: none"> <li>• Check of rheostat operation on a yearly basis by</li> </ul>

Causal Factor	Intermediate and Root Causes	Recommendations
	<p><b>Intermediate Cause 2.3:</b> Copper content of the brushes and minimum requirements were not known</p>	<p>running it from minimum to maximum resistance</p>
	<p><b>Root Cause 2.1:</b> Configuration management for brushes and springs was not maintained</p>	<ul style="list-style-type: none"> <li>• Check alignment of limit switches</li> <li>• Check brushes and brush springs</li> <li>• Check tightness of all connections</li> <li>• Apply correct conductive grease if recommended by brush manufacturer</li> </ul>
		<p><b>Recommendation 4:</b> S&amp;WB should consult with brush specialist to determine required mechanical, electrical and chemical properties to meet this application</p>
<p><b>Causal Factor 3:</b> Misalignment of brushes with contact surfaces caused arcing</p> <p><b>Background:</b> Minor surface imperfections can cause pitting which leads to arcing. Repairs performed on July 9 may not have sufficiently removed pitted surfaces</p>	<p><b>Intermediate Cause 3.1:</b> Misalignment of limit switchers in the minimum resistance position led to arcing for high current flow</p>	<p><b>Recommendation 5:</b> S&amp;WB should periodically check alignment of limit switches</p>

## 7. RECOMMENDATIONS

### 7.1. FLOOD EVENTS

#### **Recommendation 1:**

S&WB management team should develop a *Power Resiliency Plan* that establishes minimum performance requirements and operational plans to ensure backup power is provided for all drainage operations.

#### **Recommendation 2:**

New Orleans City Leadership, inclusive of the Mayor's Office, S&WB Board of Directors and senior management and the City Council, should maintain more consistent and probing situational awareness of the readiness of the city's drainage-dependent turbines and pump system assets. At a minimum, this should include monthly or more frequent reports issued by the S&WB Executive Director and submitted to S&WB Board of Directors, the Mayor, City Council and available publicly that summarizes the readiness of power and pumping operations, stated needs for repairing or restoring offline assets, the status of any such remedial actions and details on contingency plans. Further, it is recommended that if plans to repair or restore problematic turbines are not begun within three months of scheduled timelines for commencement, or are not finished within a comparable timeframe, then protocols should exist to trigger an assessment and reporting of the risks of such delays and a determination of alternative pathway solutions.

#### **Recommendation 3:**

New Orleans City Leadership, inclusive of the Mayor's Office, S&WB Board of Directors and senior management and the City Council should prepare and implement strategies to ensure adequate, sustainable and coordinated funding for operations, maintenance and capital improvements within the entire city drainage system. For example, New Orleans City leadership should collaborate jointly to create a sustainable long-term source of funding for deferred and emerging expenses within the entire city drainage system. One thoroughly researched concept is a drainage service fee whereby parcel owners pay a monthly fee based on the size of their property, discounted by the volume of water detained or otherwise held back from entering the drainage system. This fee would be used to issue bonds for deferred and future capital improvements as well as annual maintenance and operations of the entire drainage system, inclusive of assets currently separate in administration between S&WB and the City. In 2016, S&WB commissioned the completion of a proposed fee structure, which is now complete but remains in final draft form and not yet formally presented to the public.

Incident to establishing a single funding source to service the city's drainage system, S&WB and the City should consider a single, or at least better coordinated, drainage system capital planning process to more regularly establish, refine and communicate progress and hurdles on project identification and prioritization, project design and alternative vetting, fund sourcing and monthly implementation progress updates. Further, both S&WB and the City should employ a service delivery focused "budgeting for outcomes" process for establishing annual drainage system budgets based. Such a budgeting process uses drainage flow mapping and asset inspection data to set yearly performance goals and an asset

criticality hierarchy for determining annual maintenance and capital budgets, projects lists and metrics for project delivery accountability.

**Recommendation 4:**

New Orleans City Leadership, inclusive of the Mayor's Office, S&WB Board of Directors and senior management and the City Council should maintain more effective situational awareness of the status of the city's drainage system turbines and more fully consider all ramifications in deciding the allocation of turbine use for water system needs. Foremost, S&WB management should constantly and transparently monitor and evaluate the impact of maintaining its increased reliance on internally generated power on the readiness and long-term functionality of its permanent power assets and revise the proposed *Power Resiliency Plan* as required. At a minimum, S&WB's monitoring and analysis of how power allocation decisions are impacting asset reliability and vulnerability should be a regularly reported and discussed assessment as part of a regular infrastructure briefing to the Mayor and his senior advisers; along with being incorporated into more regularly scheduled public briefings to the City Council.

**Recommendation 5:**

Situational awareness relative to the construction, repair and maintenance of the city's drainage-dependent turbines should be paramount among New Orleans City leadership, inclusive of the Mayor's Office, S&WB Board of Directors and senior management and the City Council. As such, the following policy and procedural changes are recommended: (1) S&WB Board of Directors should significantly improve the frequency and effectiveness of its oversight activity by requiring monthly or more frequent reports by the S&WB Executive Director on the operational status of critical drainage systems (e.g., turbines, pumps assets and frequency converters); how many and which assets are offline; the status of maintenance projects for critical systems; and an assessment of readiness to meet a to-be-established city performance benchmark for the existing drainage system (modeled S&WB/City System design-basis rain storm scenarios); (2) Amend the state law authorizing the S&WB Executive Director and General Superintendent to pursue bid-less emergency repairs (La R.S. 33.4084) to require more stringent follow-up project status reporting requirements to the City Council and Board of Directors; (3) Amend S&WB Board of Director procedures to require a project status update for any work involving turbines at monthly general board meetings; (4) Include regular updates on the status of any repairs and maintenance involving turbines as part of any information requests made by City Council to S&WB, including during any testimony before the Council; and (5) Include a monthly status update on any emergency repairs projects involving S&WB power and pumps assets as part of schedule briefings of the Mayor by her/his cabinet and/or S&WB Board representative designee.

**Recommendation 6:**

S&WB and City leadership should consider immediately redirecting available capital and maintenance funds to resolve prioritized repair needs among the drainage system's electrical feeders. This funding should be implemented by instituting a proactive, long-term, budgeting, inspection and maintenance program to assure feeders are optimally functioning and can deliver sufficient power to meet performance benchmarks for modeled S&WB/City System design-basis rain storm scenarios. Minimally, this program should (1) Complete inspection of all system electrical feeders and prioritize replacements and repairs based on confirmed degrees of deterioration or malfunction; (2) Redirect available capital



and maintenance funds to resolve prioritized repair needs and set forth a proactive timeline and budget strategy for assuring all system feeders are optimally functioning; and (3) Institute a more proactive inspection and maintenance program that establishes clear benchmarks for gauging asset performance health (e.g., functional, problematic, eminent failure, failure) and utilizes regular inspections, repairs and related communications to leadership to assure maintenance and repairs occur expeditiously.

**Recommendation 7:**

New Orleans City Leadership, inclusive of the Mayor, S&WB Board of Directors and senior management and the City Council should advance S&WB's ongoing studies of alternative power sourcing options that would provide more reliable commercially rated electrical service for drainage operations. Specifically, City Leadership should collaborate jointly to negotiate a long-term power generation solution that involves both reliable onsite power sourcing (e.g., the long-proposed power utility substation based at the Carrollton Water Plant); as well as assuring that critical water systems, including the city's power-dependent drainage assets, are not reliant on power being transmitted via overhead distribution lines, which are highly prone to disruption.

**Recommendation 8:**

S&WB Leadership, inclusive of the Board of Directors and senior management, should establish a critical systems maintenance prioritization and tracking system. For example, S&WB should institute an investment and maintenance program that achieves the following: (1) Increases use of uniform inspection protocols and related data-based analysis to establish performance goals for each of the drainage system's drainage pumping stations (DPS) during S&WB/City System design-basis rain storm scenarios; (2) Identifies operational capacity and other resource/asset needs for each DPS to maintain those performance thresholds; (3) Centralizes the ability to assess operational status within the system's pump stations; (4) Permanently institutes a fast-track project delivery system and unit to procure, perform and monitor repair and maintenance projects, comparable to what the City and S&WB are using to manage FEMA funded street and subsurface repairs; (5) Trains personnel to use new computerized maintenance management system to centralize and integrate repair and maintenance job creation prioritizing procurement processing, information and workflow tracing and communications across departments and leadership and performance reliability tracking; and (6) Standardizes procedures across all drainage pumping stations related to operations, asset inspections, "rain load" event checks, communication protocols and repair and maintenance job requests and project tracking.

**Recommendation 9:**

Minimum design configuration and operational performance requirements should be established for drainage-dependent pumping and power assets based on realistic goals for minimizing standing water during 5, 10 and 25-year rain events. These goals should be based on modeling of the S&WB/City drainage system as presently designed and configured. Subsequently, S&WB Leadership, inclusive of the Board of Directors and senior management, should set a baseline for minimum 25 Hz power that must be able to be self-generated at any time to achieve the pumping capacity needed to meet those minimized standing water depth aims.

In the interim, S&WB Leadership should consider establishing minimum pump station flow rates required to prevent flooding during various rain event scenarios and determine baseline self-generated

power needs to achieve those rates. Further, in lieu of running turbines until failure is imminent and being forced to seek emergency repairs, S&WB Leadership should consider using a more proactive approach to maintenance based by establishing clear benchmarks for gauging asset performance health (e.g., functional, problematic, eminent failure, failure) and utilizes regular inspections, repairs and related communications to leadership to assure maintenance and repairs occur expeditiously.

**Recommendation 10:**

New Orleans City Leadership, inclusive of the Department of Public Works; S&WB Board of Directors and senior management and the City Council should develop and implement an integrated (S&WB/City) drainage asset capital improvement strategy to assure that catch basins, minor and major lines, culverts, pumps, related power assets and planned storm water retention projects are designed, scaled in capacity, coordinated in operation and repair and sustainably funded to assure that S&WB/City drainage system can attain the citywide Level of Service recommended in the City's *Stormwater Management Capital Improvement Plan* – limiting standing water to 6 inches or less amid a 10-year rain event (approximately 8.5 inches over 24 hours).

**Recommendation 11:**

New Orleans City Leadership, inclusive of the Mayor's Office, Chief Administrative Officer, Department of Public Works and the City Council, should institute a more proactive approach to maintaining City controlled drainage system assets (catch basins, ditches and minor drain lines (under 36-inches)) based on severe rain event performance modeling and inspection data in lieu of the current complaint-driven strategy. Specifically, the following action steps and policies are recommended: (1) Establish a maximum standing water depth goal in each of the City's drainage basins for 5, 10 and 25-year rain events, based on the current design and capacity of the S&WB/City system and the topography and relative imperviousness within each drainage basin; (2) Dedicate sufficient and useable funding to establish a performance baseline aligned with the above performance modeling by video-inspecting and cleaning all of the city's catch basins, ditches and minor drain lines within 3-5 years; (3) Incident to achieving this baseline, annually budget sufficient and useable funding and create policies, procedures and partnerships necessary to maintain the system on par the recommendations of the City's 2011 *Stormwater Management Capital Improvement Plan*: Annually clean at least 8% of the underground drainage system, including 15% of known problem areas (200 miles of drain lines and 18,250 catch basins); along with video inspecting at least 8% of the underground drainage system (103 miles); (4) Implement enhanced resources for training and retaining personnel along with performance incentives among contracted entities performing inspection and maintenance initiatives; (5) Ensure that monies appropriated for drainage related maintenance do not entail excess regulatory process or limits in use; (6) Require monthly status updates to the City Council and otherwise publicly available detailing progress towards reaching stated inspection and asset clearance goals; and (7) Implement cost-savings policies that reduce barriers to securing equipment, personnel and other resources necessary for meeting maintenance goals such equipment cost-sharing or asset-sharing cooperatives between the City and S&WB as well as neighboring Parish water authorities.

**Recommendation 12:**

New Orleans City Leadership, inclusive of the Mayor’s Office, Chief Administrative Officer, Department of Public Works and the City Council, should institute a more proactive approach to replacing deteriorated and undersized drainage assets within city control, while investing in increased storm water storage and detention on both public and private property. Specifically, the following action steps and policies are recommended:

Drainage Asset Replacement Measures: (1) Establish a maximum standing water depth goal in each of the City’s drainage basins for 5, 10 and 25-year rain events, based on the current design and capacity of the S&WB/City system and the topography and relative imperviousness within each drainage basin; (2) Based on those performance goals, institute a capital improvement plan with the goal of replacing compromised catch basins and undersize minor drain lines over a ten-year time period; and (3) Integrate drain line replacements into existing “Project Delivery Unit” (PDU) being used to service the \$2.3 billion FEMA-funded surface and subsurface road restoration program. While FEMA funding cannot be used to pay for drainage related improvements,<sup>51</sup> drain line replacements would be done more expeditiously using the more streamlined PDU process.

Capital Investment Funding Measures: In addition to enacting a long-term sustainable funding source for maintenance and capital improvements throughout the S&WB/City drainage system, the following complementing measures are recommended for consideration: (1) Modify existing contracting and procurement rules to allow for “Design-Build-Finance-Maintain” contracting, which could enable public-private funding options for the reconstruction of drain lines as part of adjacent development projects, offsets related to existing storm water retention requirements; or other incentive based partnership structures; (2) Enact a *Fee-In-Lieu-Of Charge* to developers when major storm water infrastructure improvements are needed to service their development; and (3) Enact an “*Availability Charge*” to developers or resident to recover their contribution to a storm water control system already constructed with finite capacity.

Stormwater Detention & Storage Investment and Incentives: Consider implementing incentives to reduce stormwater runoff and promote retention including: (1) Link zoning incentives to a fee system to allow higher than normal density if there land is also dedicated for storm water control (i.e., detention, retention, absorption, etc.); (2) Enacting an ordinance and/or executive order establishing a minimum percentage of integrated storm water control related investment among all capital project expenditures between 2018 and 2028; (3) Enact a “*green street*” ordinance or executive order with specified commitments of total pervious surface area and/or a minimum financial commitment to other storm water control features that are incorporated into street, roadway and curb improvements; and (4) Enact an ordinance and/or executive order that establishes a maximum runoff rate from public property, including parks, parkways and other public spaces.

---

<sup>51</sup> Whereas pre-Katrina inspection data existed for potable water and sewer lines to establish a pre-flood condition baseline by which FEMA was able to award recovery funding for those assets; a lack of reliable pre- and post-Katrina drain line inspection data precluded the award of FEMA funding for rebuilding drain lines.

**Recommendation 13:**

Inherent to establishing an integrated drainage system capacity design goal for the S&WB/City asset system (See Recommendation #11), New Orleans City Leadership, inclusive of City agencies and the S&WB Board of Directors and senior management, should also ascertain and communicate the risk of flooding with the city's various drainage basins that will remain within that design capacity goal; determine additional investments and restructuring that would be needed to further reduce such risk; and prepare contingency plans for reducing the risk of human endangerment, property damage, business interruption and compromised transportation mobility during rainfall that exceeds the design capacity of storm water drainage systems.

**Recommendation 14:**

New Orleans City Leadership, inclusive of S&WB, the Mayor's Office, Homeland Security and the New City Council, should enact policies and procedures that trigger coordination and communication measures whenever a "rain load" events has been designated by S&WB based on the severity of the anticipated rain event. At a minimum, this designation should entail multi-media communications to the City regarding safeguards for minimizing flood damage to property in the event of standing water beyond system capacity to dewater. Further, the City's Office of Communication should consider streamlining the protocol for approval of the issuance of public flood advisories.

**7.2. TURBINE GENERATOR #1 ELECTRICAL FAULT**

Recommendations for Causal Factors and Intermediate Causes

The following actions are recommended as soon as possible to mitigate the potential for additional arcing issues:

- Ensure brushes are seated on both the ring and the switching contacts. Use of fine sand paper will suffice. Do not use emery cloth.
- Check spring tensions with an appropriate spring scale. All four springs should place the same pressure on the brushes.
- Ensure that the limit switches are installed correctly and adjusted in a way not to allow the brushes to ride off any contact surface area. This is most important in the minimum resistance position as that is where the most current is being conducted.
- Confirm that the rheostat is being installed in the correct location, that is, as shown on DWG. No. 4135-P-2.
- Open both breakers, check to see that there is no voltage on the rheostat and then operate the rheostat to make sure the resistance across the rheostat measures as expected, that is, maximum to minimum resistance in steps.
- Consult with brush specialist to confirm brush grade is appropriate for the use. The brushes appear to be high in copper content.

A preventive maintenance plan for the field rheostat should be established to include the following:

- Check rheostat operation on a yearly basis by running it from minimum to maximum resistance.
- Check brushes and brush springs.
- Check tightness of all connections.
- Apply correct conductive grease if recommended by brush manufacturer.

**Recommendation 1:** S&WB should develop procedures for repair of critical equipment which requires adequate testing and independent checks

**Recommendation 2:** S&WB should consult with an application engineer with a reputable brush supplier to develop configuration control for field rheostat equipment to include mechanical, electrical and chemical properties

**Recommendation 3:** S&WB should prepare preventive maintenance plans for field rheostats

**Recommendation 4:** S&WB should consult with brush specialist to determine required mechanical, electrical and chemical properties to meet this application.

**Recommendation 5:** S&WB should periodically check alignment of limit switches

## **8. REFERENCES**

**BCG 2015** - BCG (BCG Engineering and Consulting, Inc.), Engineering Investigation of Broadmoor Basin Drainage System, for the Sewerage and Water Board of New Orleans, July 2015.

**BCG 2010** - BCG (BCG Engineering and Consulting, Inc.), "Historical/Technical Paper on S&WB Drainage System Capacity," for the Sewerage and Water Board of New Orleans, n.d. [Referred to as "1<sup>st</sup> Hour Performance White Paper"]

**CDM Smith**, *City of New Orleans Stormwater Management Capital Improvements Plan*. 2 vols. & appendices, 2010.

**BCG 2005** - BCG (Brown, Cunningham & Gannuch), *Master Drainage Plan for the City of New Orleans, Phase I*, Main Report. May 2005.

**B&V 2015** - Black & Veatch, *Report on Operations 2015*, for the Sewerage and Water Board of New Orleans, 20 October 2016.

**CH2M 2018** - CH2M, *Power Alternatives Assessment*, for the Sewerage and Water Board of New Orleans, February 2018.

**Lincoln 2017** - Lincoln, W. Scott, *Rainfall Analysis for the August 5, 2017, New Orleans Flash Flood Event*, National Weather Service, October 12, 2017.

Schlotzhauer, David and W. Scott Lincoln, "Using New Orleans Pumping Data to Reconcile Gauge Observations of Isolated Extreme Rainfall due to Hurricane Isaac," *J. Hydrol. Eng.*, 2016, 21(9): -1—1 [online access].

**IPET 2009** - US Army Corps of Engineers, *Performance Evaluation of the New Orleans and Southeast Louisiana Hurricane Protection System (IPET)*, Final Report. 8 vols. & appendices, June 2009.

**VEOLIA 2015** - Veolia, *Drainage System Condition Assessment for the Sewerage and Water Board of New Orleans, Louisiana*, Final Report, March 15, 2018.